

صنایع روشنایی

تکشیدفام



2023



Takshidfam
Lighting Industries

تولیدکننده چراغ‌های محوطه‌ای آلومینیومی به روش دایکاست

www.takshidfam.com

info@takshidfam.com

درباره ما









شرکت صنایع روشنایی تکشیدفام شب افروز با هدف کار آفرینی اقدام به تولید انواع چراغ محوطه ای و پایه چراغ محوطه ای کرده است. که این کار را در فضایی با مساحتی بالغ بر ۵ هزار مترمربع تاسیس و با بروزترین ماشین آلات تولیدی تجهیز کرده است. در حال حاضر این شرکت با مدنظر قرار دادن احتیاجات روز دنیا و همچنین کشور عزیزمان ایران و با شناخت کامل در مورد خریداران اصلی مینی بر ارائه کالای با کیفیت، و با دستیابی به آخرین فناوری های روز دنیا و ایجاد تنوع در سبد محصولات تولیدی با طراحی و خلق بروزترین مدل ها در رسته چراغهای مدرن و کلاسیک توانسته جایگاه خود را به عنوان یکی از بزرگترین تولید کنندگان محصولات روشنایی شناسانده و تثبیت نماید. لازم به ذکر است که این شرکت با بهره مندی از پرسنل مجرب و مدیران توانمند خود و همچنین دارا بودن واحدهای مختلف از قبیل طراحی، قالب سازی، تزریق پلاستیک، تزریق دایکاست، پرداخت کاری، جوشکاری، شست و شوی شیمیایی، خطوط پیشرفته رنگ بودر الکترواستاتیک، واحد مونتاژ، واحد کنترل کیفیت و فروش، سرعت در تولید و تحویل کالا را به حداقل رسانده و ضمانت نامه کیفیت محصول و تضمین تأمین قطعات یدکی را تا ۱۰ سال مطابق با استانداردهای معتبر داخلی و اروپایی را دارد. در ضمن این شرکت سعی در توسعه کمی و کیفی محصولات خود را داشته و هدف نهایی خود را رضایت مندی مشتریان عزیز به عنوان محور اصلی اهداف خود قرار داده است.









صنایع روشنایی تکشیدفام افتخار این را دارد که با گردآوری مجموعه ای مفصل از انواع چراغ پارکی، چراغ محوطه ای، چراغ چمنی چراغ ویلایی، چراغ دیواری و انواع پایه چراغ آلومینیومی برای مصارف مختلف روشنایی و نورپردازی خدمت جدیدی به مشتریان خود عرضه نموده است. نکته قابل توجه این است که چراغ های محوطه ای این واحد تولیدی مشابه ایرانی دیگری ندارد.









Takshidfam Lighting Industries Co., with the aim of entrepreneurship, produces various types of outdoor lights and outdoor lamp bases. The company has established itself in a space with an area of 5000 sq. m. and is equipped with the most up-to-date production machines. Currently, this company considers the needs of both the world and our country, Iran. With full knowledge of the main buyers, it provides high-quality goods and incorporates the latest technologies. The company also creates diversity in its portfolio of manufactured products by designing and creating the most up-to-date models in the series of modern and classic lights. As a result, it has achieved recognition and stability as one of the largest manufacturers of lighting products. It is worth noting that the company has experienced personnel and capable managers, as well as various units such as design, mold making, plastic injection, die-cast injection, polishing, welding, chemical washing, advanced paint lines, electrostatic powder, assembly units, quality control, and sales units. This setup minimizes the production and delivery time while ensuring product quality. The company also offers a 10-year guarantee on product quality and the supply of spare parts, following valid domestic and European standards.





Moreover, the company prioritizes customer satisfaction as its main goal. Takshidfam Lighting Industries proudly offers a new service to its customers—a comprehensive collection of park lights, outdoor lights, lawn lights, villa lights, wall lights, and aluminum lamp bases for various lighting purposes. It is worth mentioning that the outdoor lights produced by this unit are distinct from any other Iranian products.



	روبینا Robbina	48
	پالیز palliz	50
	وستا بزرگ Great Vesta	52
	مهرگان Mehrgan	54
	وستا کوچک Small Vesta	56
	پادرا Paadra	58
	پادینا Paddina	60
	پادینا طرح دار Pattern paddina	61
	انواع پایه چراغ Lamp Post's Type	62

	معبد رابو Rabo's Temple	37
	معبد ویسپر Whisper's Temple	39
	ویکتوریا Victoria	40
	ویکتور Victor	41
	رابو خمیره ای Vase Rabo	42
	رابو کمرباریک Slim Rabo	43
	معبد رابو خمیره ای Vase Rabo's Temple	44
	معبد رابو کمرباریک Slim Rabo's Temple	45
	کلبه Cottage	46

	آرتمیس Artemis	24
	آرامیس Aramis	26
	آرمیتا Armita	27
	نیکا Nikka	28
	آيسان Aisan	29
	کارن Karen	30
	ویدا Vida	31
	رابو Rabo	33
	ویسپر Whisper	35

	سورن Soren	8
	سورن کوتاه Short Soren	10
	معبد سورن Soren's Temple	12
	معبد سورن کوتاه Short Soren's Temple	14
	سورنا Sorna	16
	سورنا کوتاه Short Sorna	18
	معبد سورنا Sorna's Temple	20
	معبد سورنا کوتاه Short Sorna's Temple	22



فرایند و واحدهای بخش تولید
صنایع روشنایی تکشیدفام





فرایند و واحدهای بخش تولید
صنایع روشنایی تکشیدفام



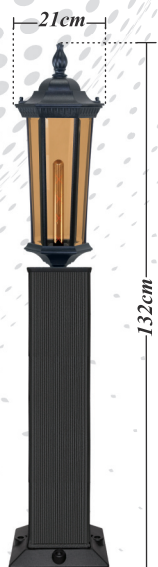

code: 111022 & 970752



code: 111012A



code: 111032B



code: 111022 & 910772

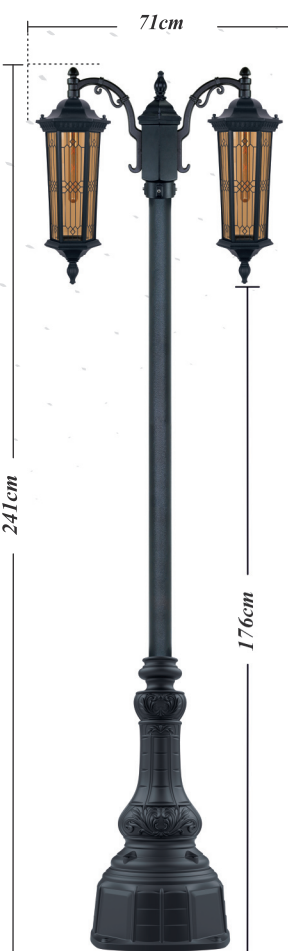

code: 112112A & 972022

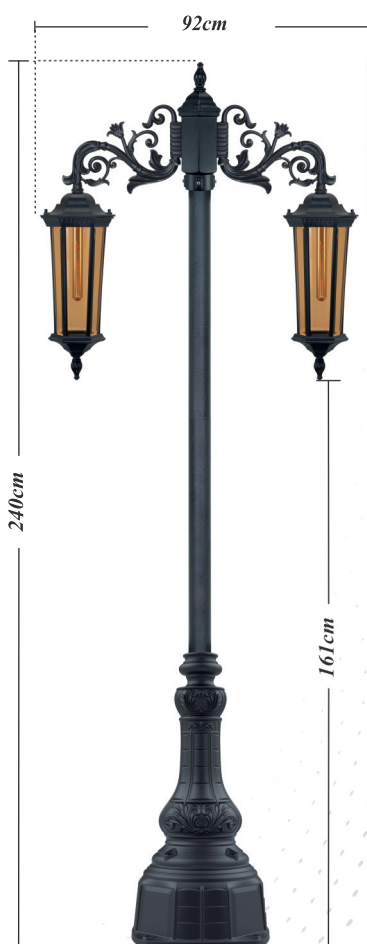

code: 112412 & 972022

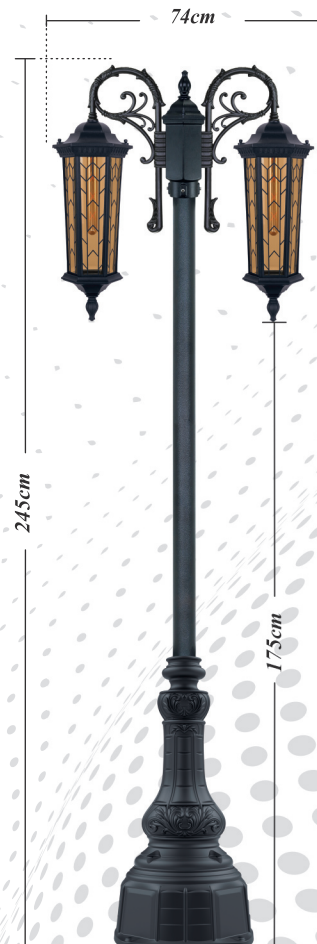

code: 112312B & 972022

سورن

- منبع مصرفی لامپ: E27
- جنس بدنه: آلومینیوم دایکاست
- جنس حباب: شیشه
- درجه حفاظت: IP 44
- پوشش بدنه: رنگ پودری الکترواستاتیک
- توان: 30W
- رنگ بدنه: ■ ■
- ولتاژ ورودی: AC220V/50HZ
- پیچ: استیل

SOREN

- Lamp consumption source: E27
- Property of Body: Die-cast aluminum
- Property of bubble: Glass
- IP degree of Protection: 44
- Body coating: electrostatic power paint
- Power: 30 W
- Color of body: ■ ■
- Input Voltage: AC220V/50HZ
- Screw: Steel



code: 110212



code: 110122A



code: 110312A



code: 110712



code: 110412

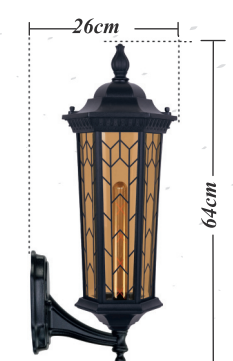

code: 110622B



code: 110512B



code: 111028 & 970752

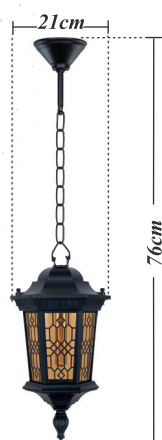

code: 111018A



code: 111038B



code: 111028 & 910772

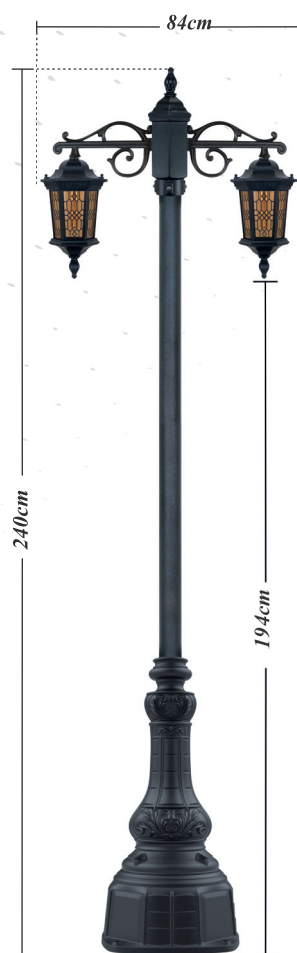

code: 112718A & 972022

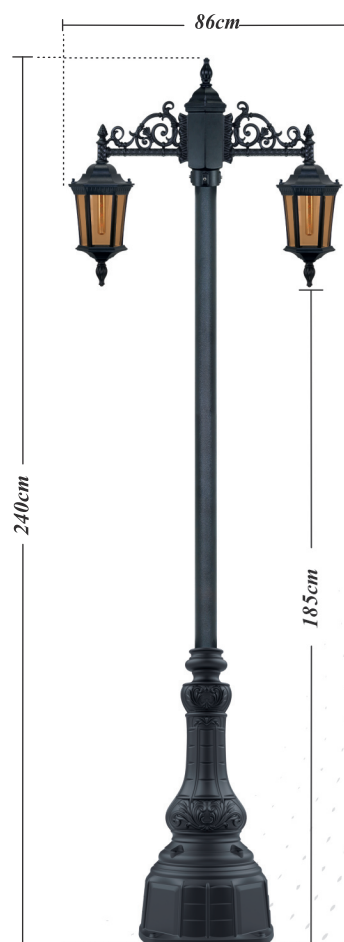

code: 112518 & 972022

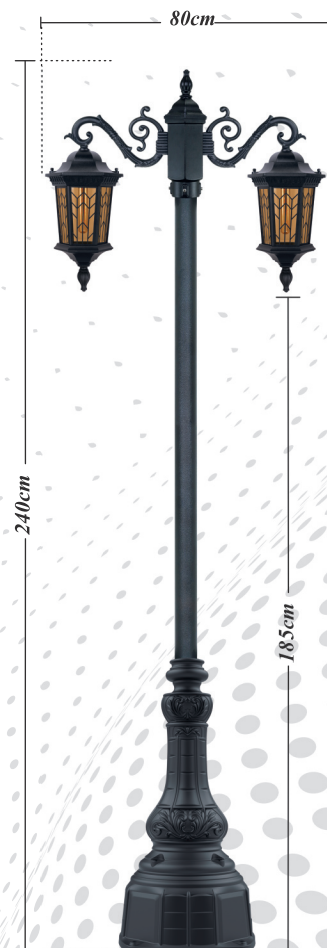

code: 112218B & 972022

سورن کوتاه

- منبع مصرفی لامپ: E27
- جنس بدنه: آلومینیوم دایکاست
- جنس حباب: شیشه
- درجه حفاظت: IP 44
- پوشش بدنه: رنگ پودری الکترواستاتیک
- توان: 30W
- رنگ بدنه: ■ ■
- ولتاژ ورودی: AC220V/50HZ
- پیچ: استیل

Short Soren

- Lamp consumption source: E27
- Property of Body: Die-cast aluminum
- Property of bubble: Glass
- IP degree of Protection: 44
- Body coating: electrostatic power paint
- Power: 30 W
- Color of body: ■ ■
- Input Voltage: AC220V/50HZ
- Screw: Steel



code: 110728



code: 110128A



code: 110318A



code: 110218



code: 110418



code: 110628B



code: 110528B

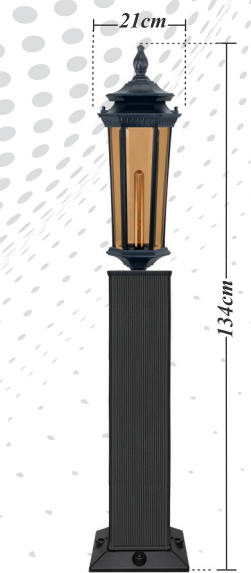

code: 121022 & 970752



code: 121012A



code: 121032B

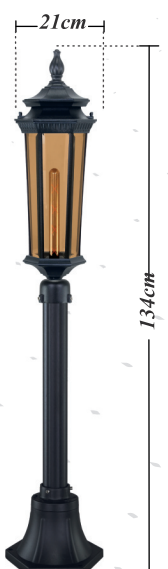

code: 121022 & 910772

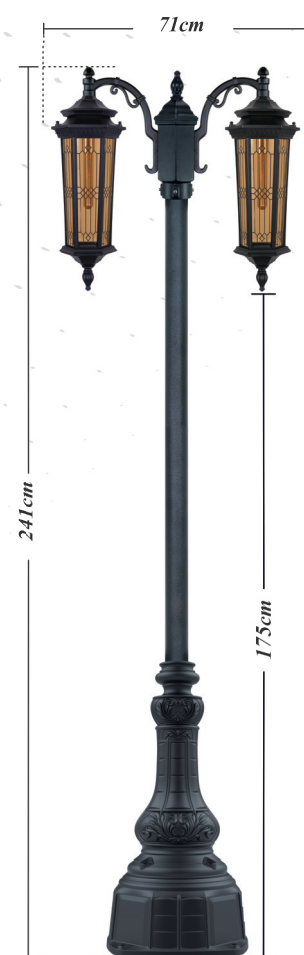

code: 122112A & 972022

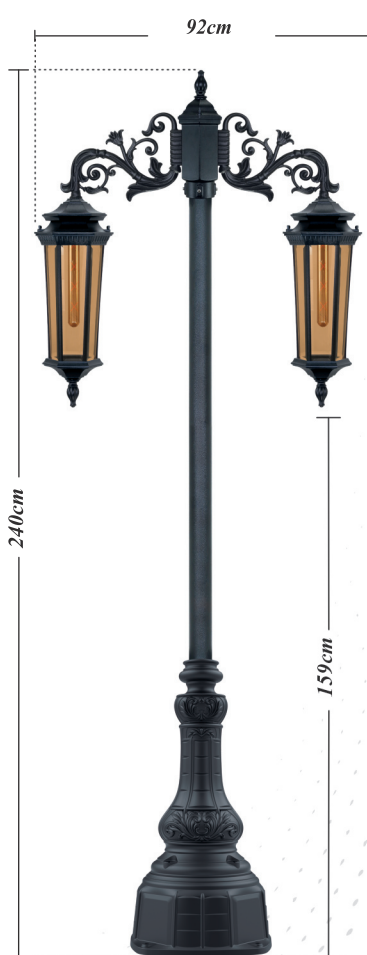

code: 122412 & 972022

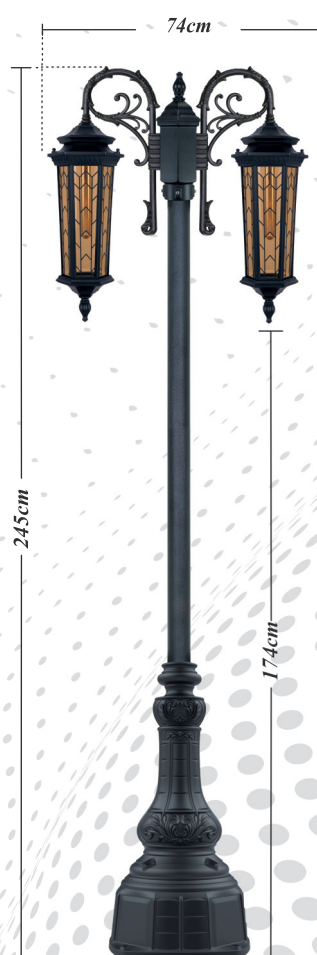

code: 122312B & 972022

معبد سورن

- منبع مصرفی لامپ: E27
- جنس بدنه: آلومینیوم دایکاست
- جنس حباب: شیشه
- درجه حفاظت: IP 44
- پوشش بدنه: رنگ پودری الکترواستاتیک
- توان: 30W
- رنگ بدنه: ■ ■
- ولتاژ ورودی: AC220V/50HZ
- پیچ: استیل

Soren's Temple

- Lamp consumption source: E27
- Property of Body: Die-cast aluminum
- Property of bubble: Glass
- IP degree of Protection: 44
- Body coating: electrostatic power paint
- Power: 30 W
- Color of body: ■ ■
- Input Voltage: AC220V/50HZ
- Screw: Steel



code: 120312



code: 120122A



code: 120622A

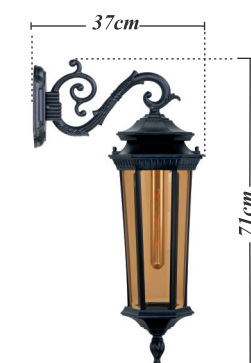

code: 120212



code: 120412



code: 120712B



code: 120522B



code: 121028 & 970752

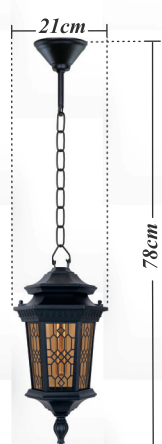

code: 121018A



code: 121038B



code: 121028 & 910772

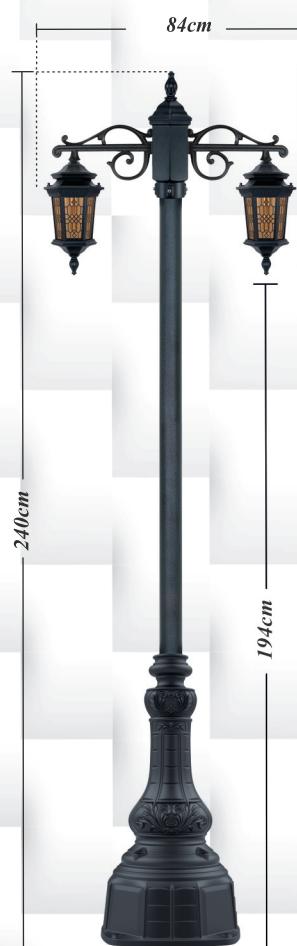

code: 122718A & 972022

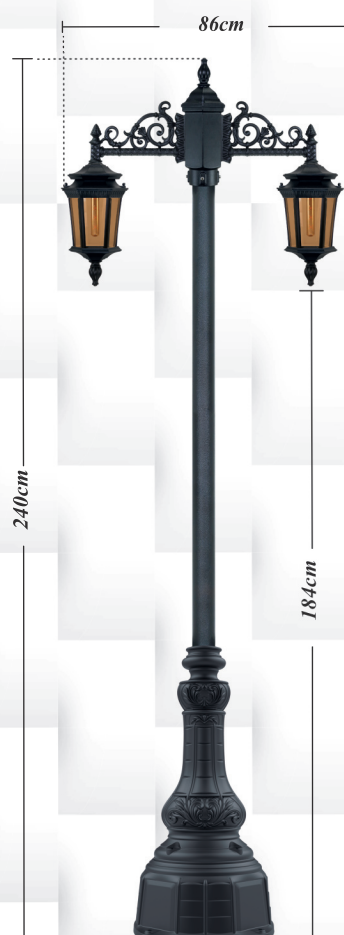

code: 122518 & 972022

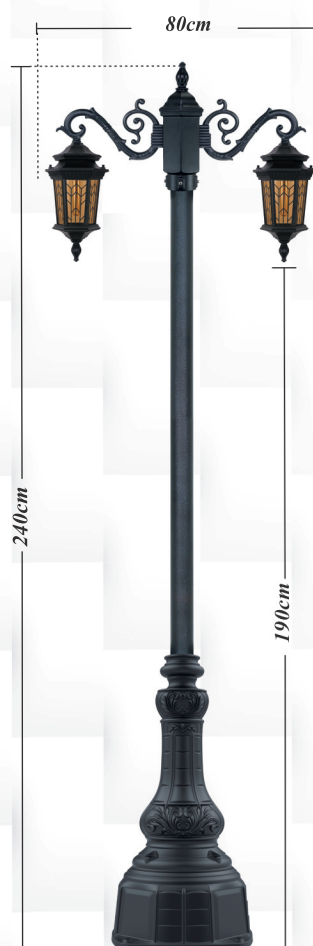

code: 122218B & 972022

معبد سورن کوتاه

- منبع مصرفی لامپ: E27
- جنس بدنه: آلومینیوم دایکاست
- جنس حباب: شیشه
- درجه حفاظت: IP 44
- پوشش بدنه: رنگ پودری الکترواستاتیک
- توان: 30W
- رنگ بدنه: ■ ■
- ولتاژ ورودی: AC220V/50HZ
- پیچ: استیل

Short Soren's Temple

- Lamp consumption source: E27
- Property of Body: Die-cast aluminum
- Property of bubble: Glass
- IP degree of Protection: 44
- Body coating: electrostatic power paint
- Power: 30 W
- Color of body: ■ ■
- Input Voltage: AC220V/50HZ
- Screw: Steel



code: 120428



code: 120128A



code: 120218



code: 120728B



code: 120628A



code: 120318



code: 120528B

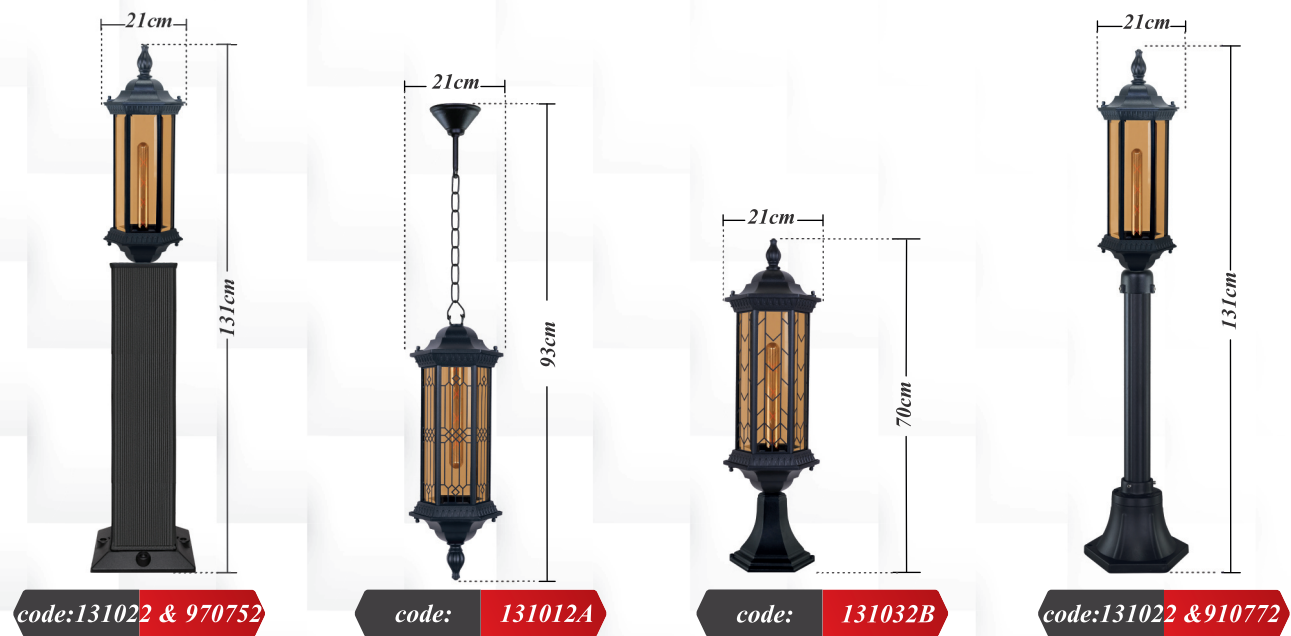

سورنا

- منبع مصرفی لامپ: E27
- جنس بدنه: آلومینیوم دایکاست
- جنس حباب: شیشه
- درجه حفاظت: IP 44
- پوشش بدنه: رنگ پودری الکترواستاتیک
- توان: 30W
- رنگ بدنه: ■ ■
- ولتاژ ورودی: AC220V/50HZ
- پیچ: استیل

Sorna

- Lamp consumption source: E27
- Property of Body: Die-cast aluminum
- Property of bubble: Glass
- IP degree of Protection: 44
- Body coating: electrostatic power paint
- Power: 30 W
- Color of body: ■ ■
- Input Voltage: AC220V/50HZ
- Screw: Steel

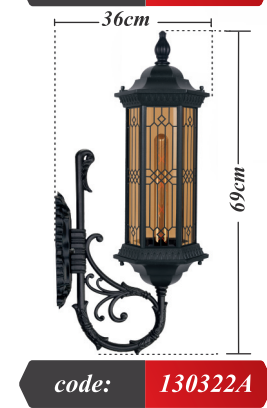



code: 131028 & 970752



code: 131018A



code: 131038B



code: 131028 & 910772

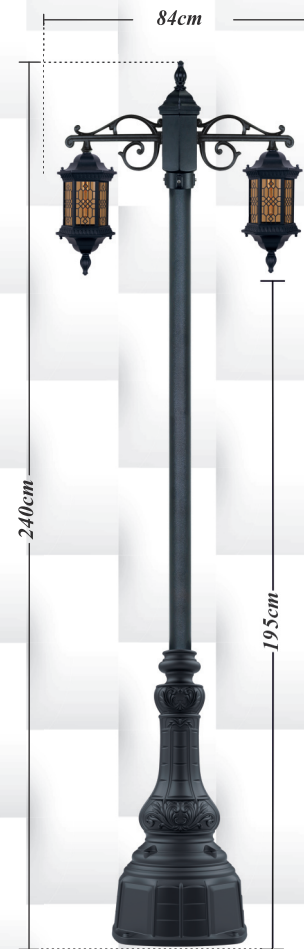

code: 132718A & 972022

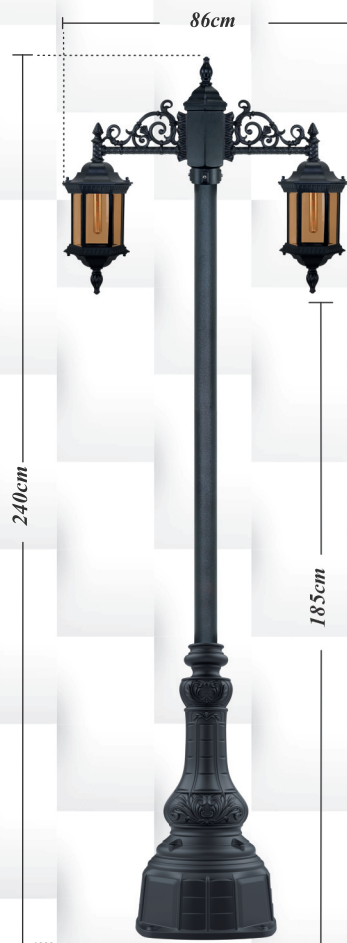

code: 130518 & 972022

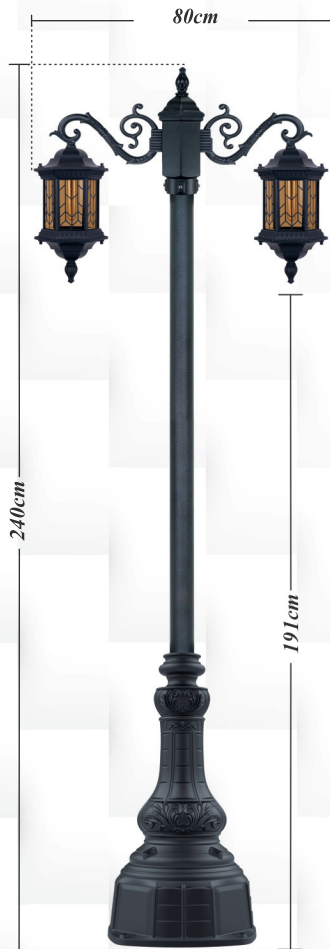

code: 132218B & 972022

سورنا کوتاه

- منبع مصرفی لامپ: E27
- جنس بدنه: آلومینیوم دایکاست
- جنس حباب: شیشه
- درجه حفاظت: IP 44
- پوشش بدنه: رنگ پودری الکترواستاتیک
- توان: 30W
- رنگ بدنه: ■ ■
- ولتاژ ورودی: AC220V/50HZ
- پیچ: استیل

Short Sorna

- Lamp consumption source: E27
- Property of Body: Die-cast aluminum
- Property of bubble: Glass
- IP degree of Protection: 44
- Body coating: electrostatic power paint
- Power: 30 W
- Color of body: ■ ■
- Input Voltage: AC220V/50HZ
- Screw: Steel



code: 130128



code: 130218A



code: 130728



code: 130618B



code: 130328A



code: 130418



code: 130528B

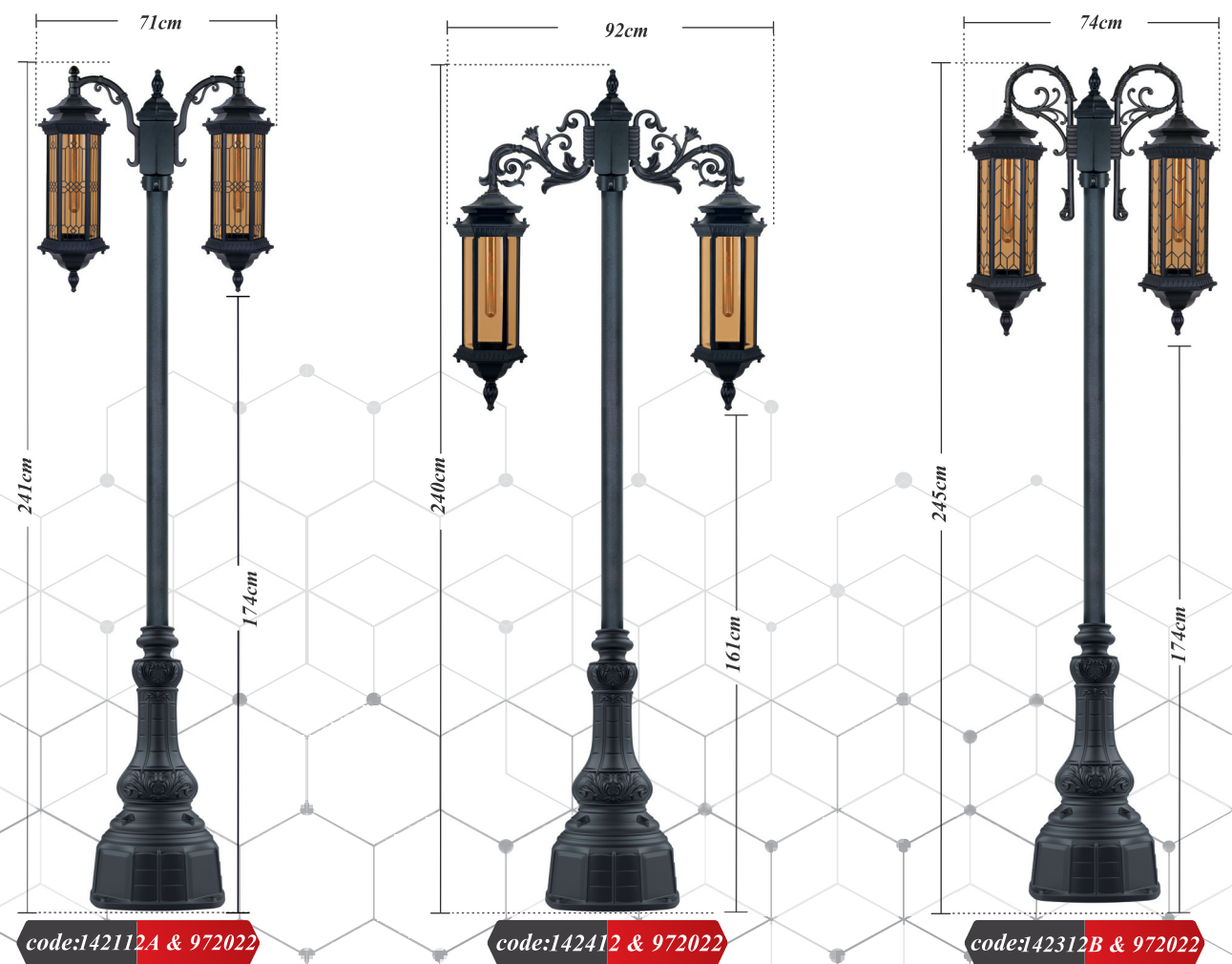
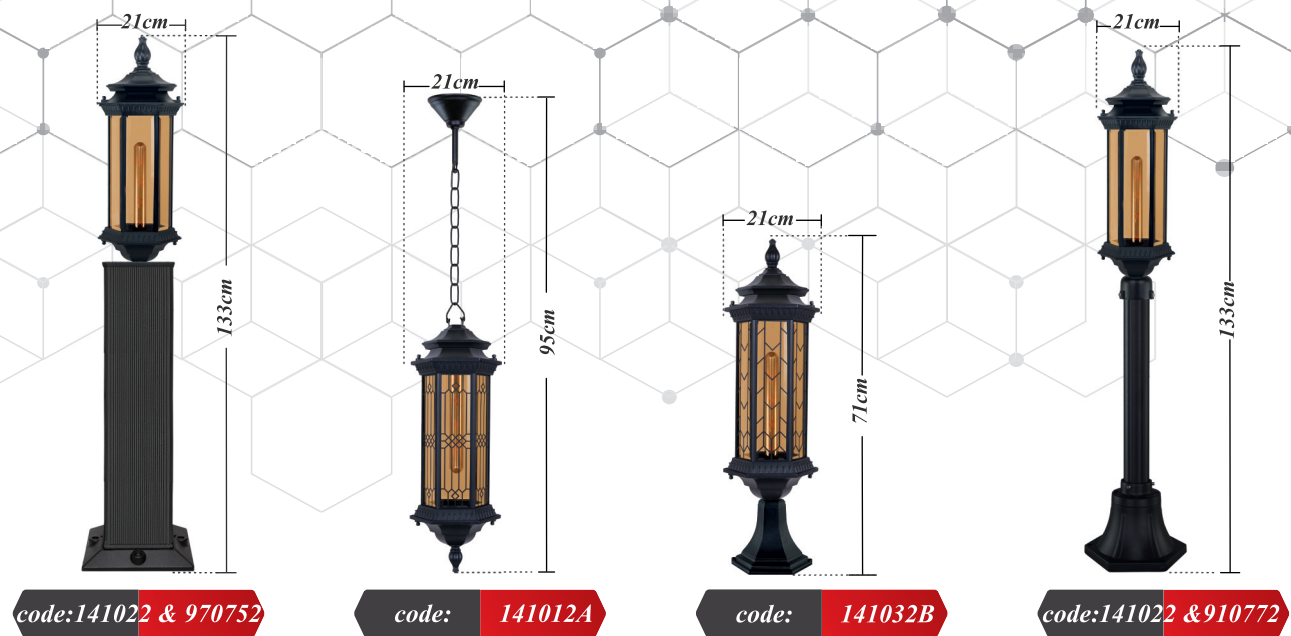

معبد سورنا

- منبع مصرفی لامپ: E27
- جنس بدنه: آلومینیوم دایکاست
- جنس حباب: شیشه
- درجه حفاظت: IP 44
- پوشش بدنه: رنگ پودری الکترواستاتیک
- توان: 30W
- رنگ بدنه: ■ ■
- ولتاژ ورودی: AC220V/50HZ
- پیچ: استیل

Sorna's Temple

- Lamp consumption source: E27
- Property of Body: Die-cast aluminum
- Property of bubble: Glass
- IP degree of Protection: 44
- Body coating: electrostatic power paint
- Power: 30 W
- Color of body: ■ ■
- Input Voltage: AC220V/50HZ
- Screw: Steel

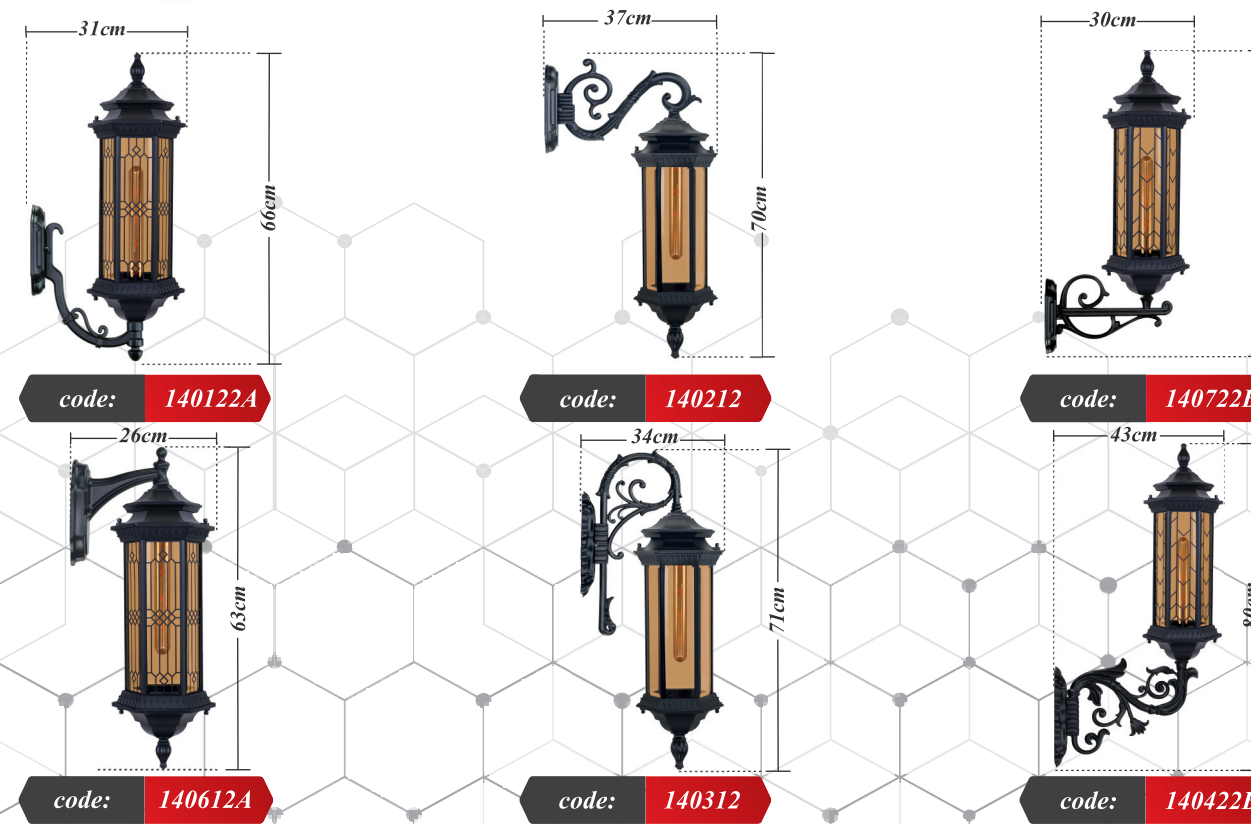
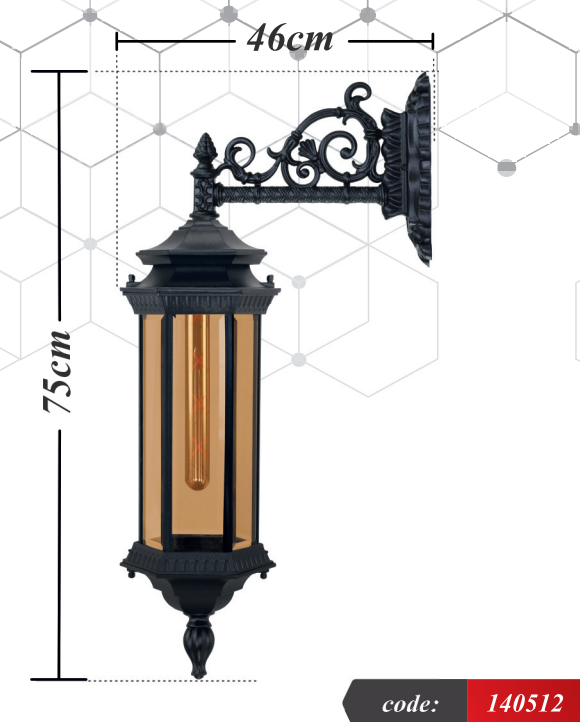



code:141028 & 970752

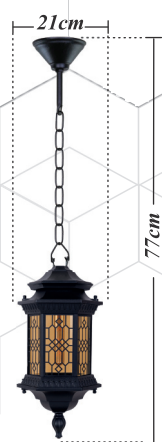

code: 141018A



code: 141038B



code:141028 & 910772

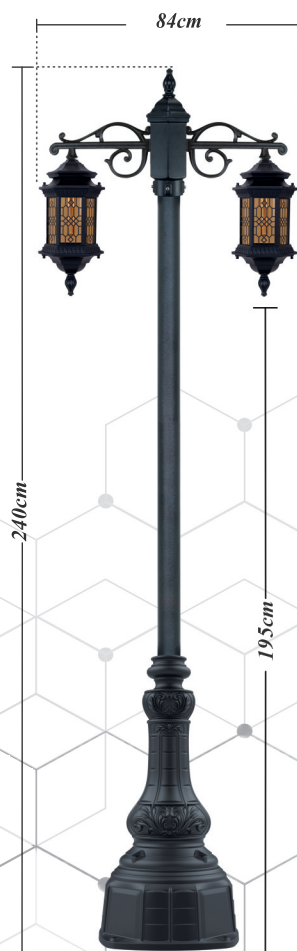

code:142718A & 972022

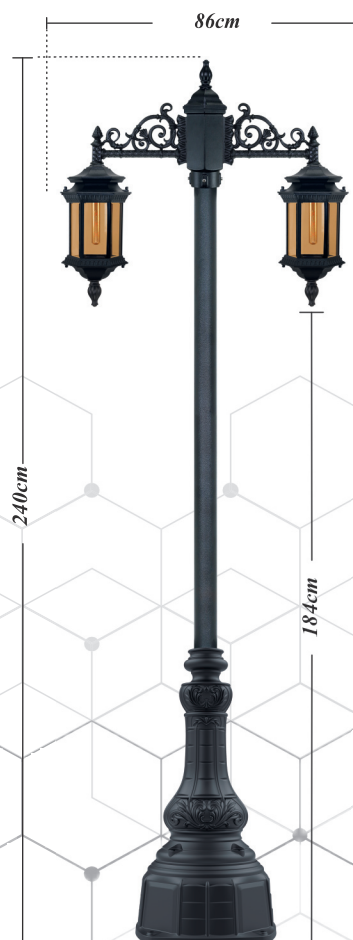

code:142518 & 972022

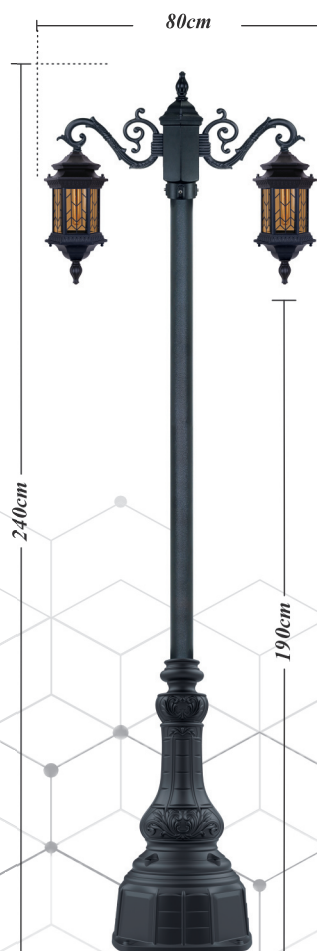

code:142218B & 972022

معبد سورنا کوتاه

- منبع مصرفی لامپ: E27
- جنس بدنه: آلومینیوم دایکاست
- جنس حباب: شیشه
- درجه حفاظت: IP 44
- پوشش بدنه: رنگ پودری الکترواستاتیک
- توان: 30W
- رنگ بدنه: ■ ■
- ولتاژ ورودی: AC220V/50HZ
- پیچ: استیل

Short Sorna's Temple

- Lamp consumption source: E27
- Property of Body: Die-cast aluminum
- Property of bubble: Glass
- IP degree of Protection: 44
- Body coating: electrostatic power paint
- Power: 30 W
- Color of body: ■ ■
- Input Voltage: AC220V/50HZ
- Screw: Steel



code: 140128



code: 140218A



code: 140728



code: 140618B

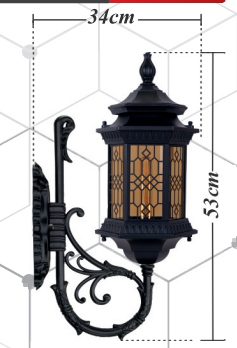

code: 140328A

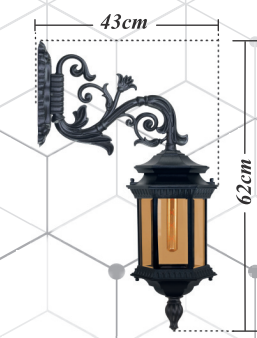

code: 140418



code: 140528B



code: 202002

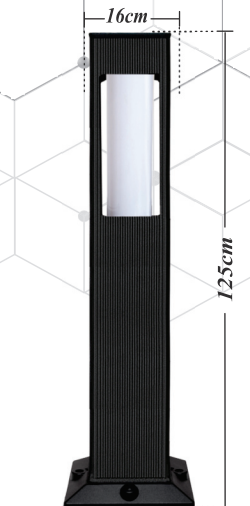

code: 201252

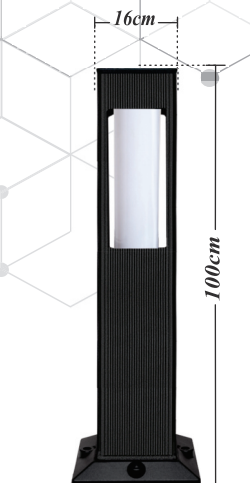

code: 201002

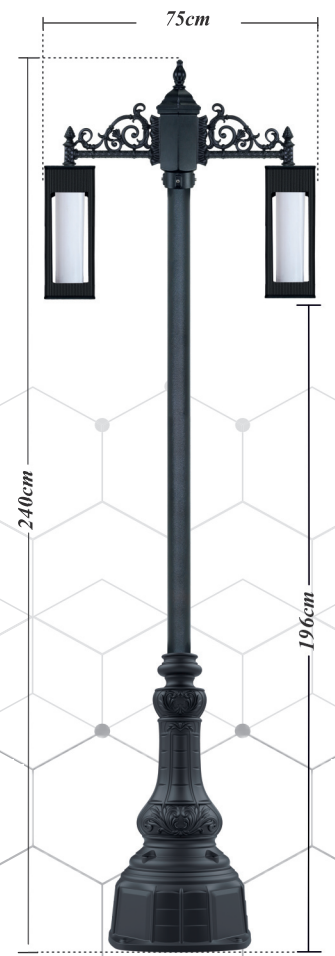

code: 202512 & 972022

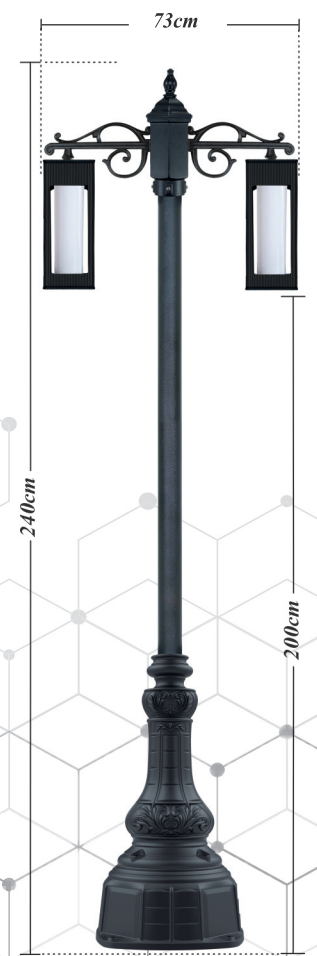

code: 202712 & 972022



آرتمیس

- منبع مصرفی لامپ: ماژول
- جنس بدنه: آلومینیوم دایکاست
- جنس حباب: پلی کربنات
- درجه حفاظت: IP 44
- پوشش بدنه: رنگ پودری الکترواستاتیک
- توان: 24W
- رنگ بدنه: ■
- ولتاژ ورودی: AC220V/50HZ
- پیچ: استیل

Aramis

- Lamp consumption source: module
- Property of Body: Die-cast aluminum
- Property of bubble: Polycarbonate
- IP degree of Protection: 44
- Body coating: electrostatic power paint
- Power: 24 W
- Color of body: ■
- Input Voltage: AC220V/50HZ
- Screw: Steel

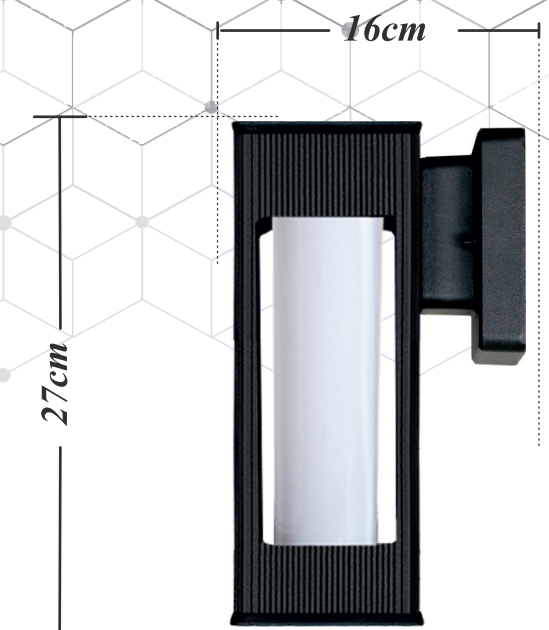

code: 200812

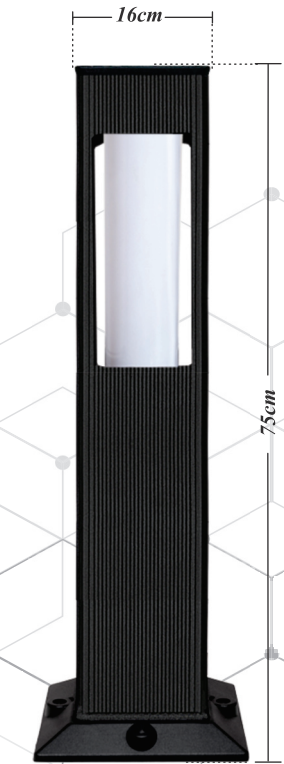

code: 200752

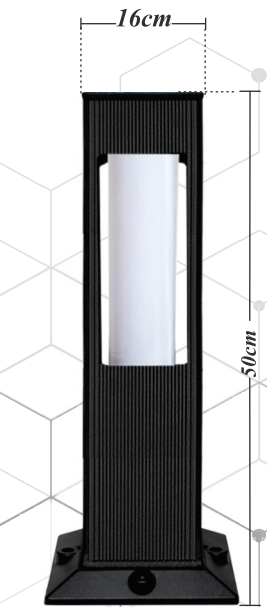

code: 200502

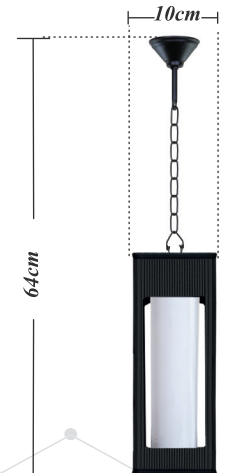

code: 200322

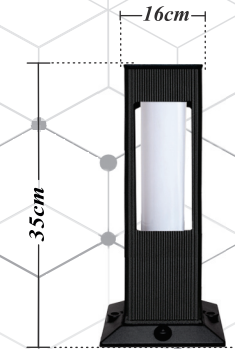

code: 200352



code: 220822

آرمیتا

- منبع مصرفی لامپ: E27
- جنس بدنه: آلومینیوم دایکاست
- جنس حباب: پلی کربنات
- درجه حفاظت: IP 44
- پوشش بدنه: رنگ پودری الکترواستاتیک
- توان: 30W
- رنگ بدنه: ■
- ولتاژ ورودی: AC220V/50HZ
- پیچ: استیل

Armita

- Lamp consumption source: E27
- Property of Body: Die-cast aluminum
- Property of bubble: Polycarbonate
- IP degree of Protection: 44
- Body coating: electrostatic power paint
- Power: 30 W
- Color of body: ■
- Input Voltage: AC220V/50HZ
- Screw: Steel

آرامیس

- منبع مصرفی لامپ: ماژول
- جنس بدنه: آلومینیوم دایکاست
- جنس حباب: پلی کربنات
- درجه حفاظت: IP 44
- پوشش بدنه: رنگ پودری الکترواستاتیک
- توان: 24W
- رنگ بدنه: ■
- ولتاژ ورودی: AC220V/50HZ
- پیچ: استیل

Aramis

- Lamp consumption source: module
- Property of Body: Die-cast aluminum
- Property of bubble: Polycarbonate
- IP degree of Protection: 44
- Body coating: electrostatic power paint
- Power: 24 W
- Color of body: ■
- Input Voltage: AC220V/50HZ
- Screw: Steel



code: 210822

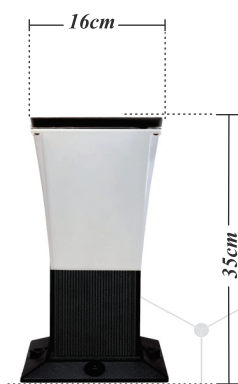

code: 220352



code: 220502



code: 220752

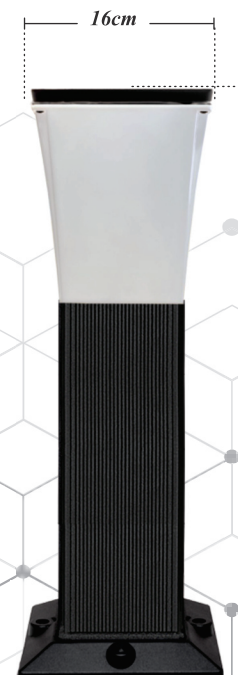

code: 221002

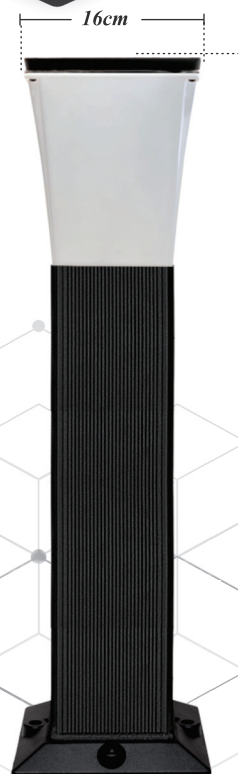

code: 221252

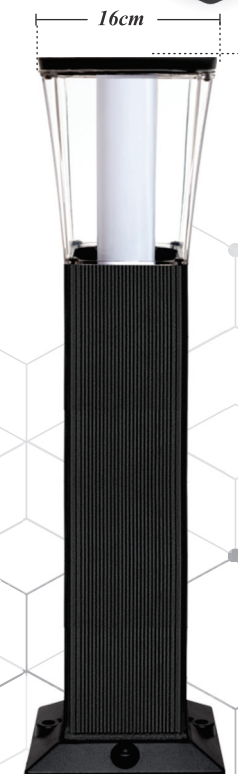

code: 211252

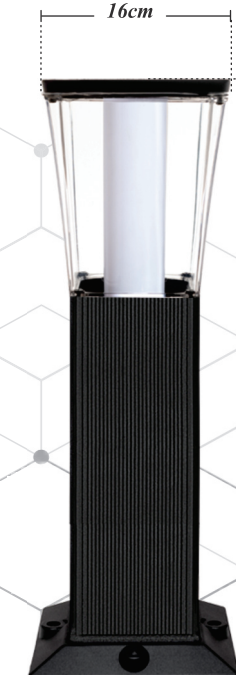

code: 211002



code: 210752

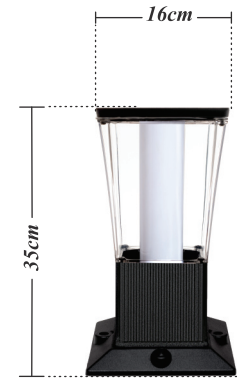

code: 210352



code: 210502

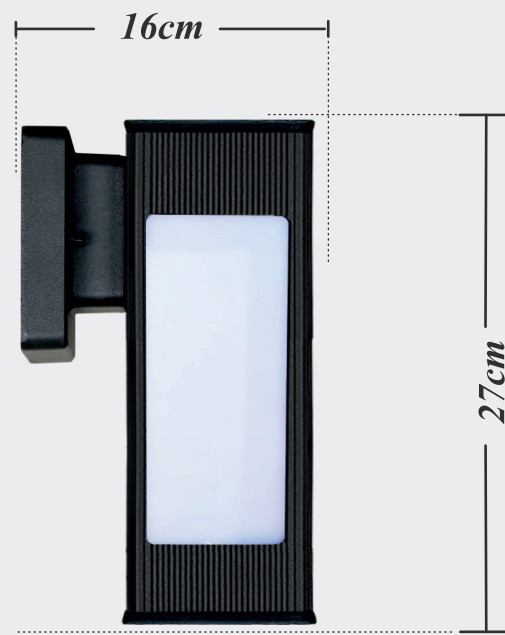

code: 240811

ایسان

- منبع مصرفی لامپ: E27
- جنس بدنه: آلومینیوم دایکاست
- جنس حباب: پلی کریبات
- درجه حفاظت: IP 53
- پوشش بدنه: رنگ پودری الکترواستاتیک
- توان: 30W
- رنگ بدنه: ■
- ولتاژ ورودی: AC220V/50HZ
- پیچ: استیل

AISAN

- Lamp consumption source: E27
- Property of Body: Die-cast aluminum
- Property of bubble: Polycarbonate
- IP degree of Protection: 53
- Body coating: electrostatic power paint
- Power: 30 W
- Color of body: ■
- Input Voltage: AC220V/50HZ
- Screw: Steel

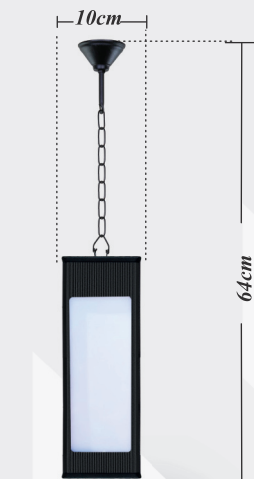

code: 240322

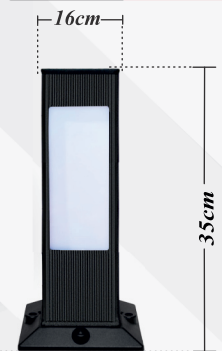

code: 240352



code: 240502



code: 240752



code: 241002

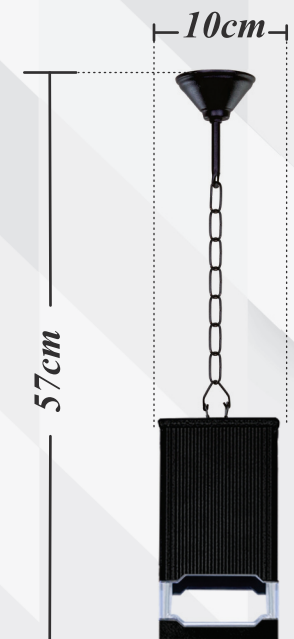

code: 230211

نیکا

- منبع مصرفی لامپ: ماژول و لامپ
- جنس بدنه: آلومینیوم دایکاست
- جنس حباب: پلی کریبات
- درجه حفاظت: IP 53
- پوشش بدنه: رنگ پودری الکترواستاتیک
- توان: 24W
- رنگ بدنه: ■
- ولتاژ ورودی: AC220V/50HZ
- پیچ: استیل

Nikka

- Lamp consumption source: module & Lamp
- Property of Body: Die-cast aluminum
- Property of bubble: Polycarbonate
- IP degree of Protection: 53
- Body coating: electrostatic power paint
- Power: 24 W
- Color of body: ■
- Input Voltage: AC220V/50HZ
- Screw: Steel

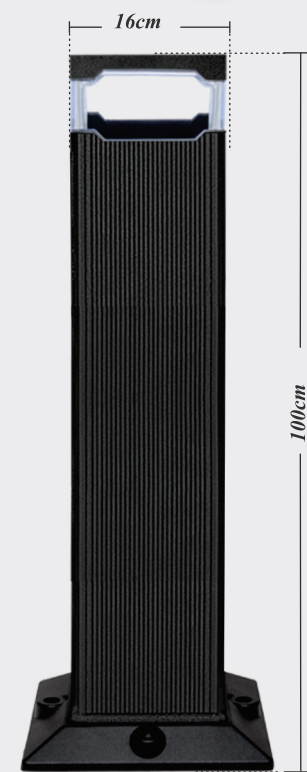

code: 231001

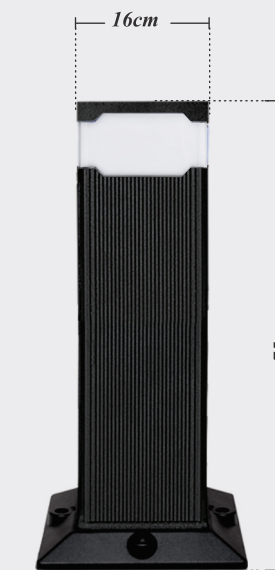

code: 230752

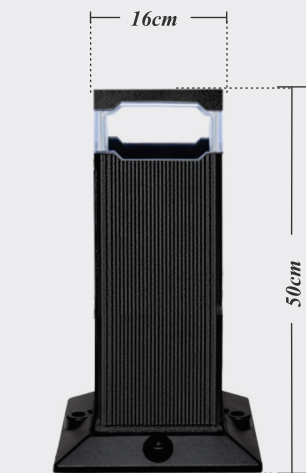

code: 230501

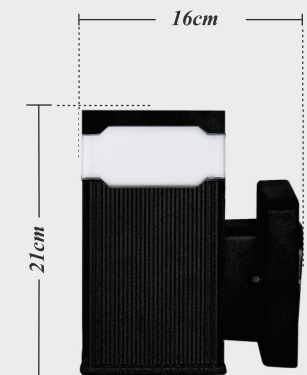

code: 230822

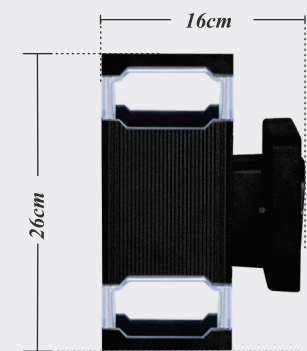

code: 232821



code: 261012



code: 261032



code: 260822

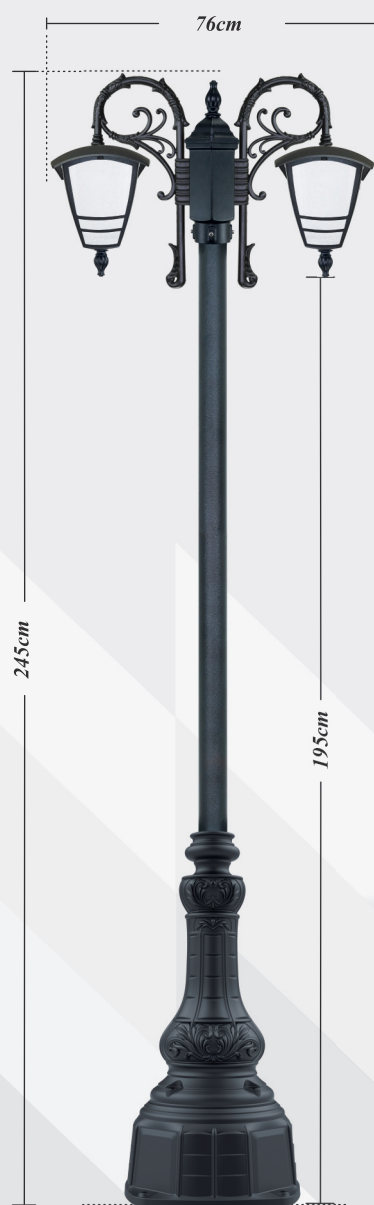

code: 262312 & 972022



code: 261022 & 910772

ویدا

- منبع مصرفی لامپ: E27
- جنس بدنه: آلومینیوم دایکاست
- جنس حباب: پلی کربنات
- درجه حفاظت: IP 44
- پوشش بدنه: رنگ پودری الکترواستاتیک
- توان: 30W
- رنگ بدنه: ■ ■
- ولتاژ ورودی: AC220V/50HZ
- پیچ: استیل

Vida

- Lamp consumption source: E27
- Property of Body: Die-cast aluminum
- Property of bubble: Polycarbonate
- IP degree of Protection: 44
- Body coating: electrostatic power paint
- Power: 30 W
- Color of body: ■ ■
- Input Voltage: AC220V/50HZ
- Screw: Steel

کارن

- منبع مصرفی لامپ: E27
- جنس بدنه: UPVC
- جنس حباب: پلی کربنات
- درجه حفاظت: IP 53
- توان: 30W
- رنگ بدنه: ■
- ولتاژ ورودی: AC220V/50HZ
- پیچ: استیل

KAREN

- Lamp consumption source: E27
- Property of Body: UPVC
- Property of bubble: Polycarbonate
- IP degree of Protection: 53
- Power: 30W
- Color of body: ■
- Input Voltage: AC220V/50HZ
- Screw: Steel



code: 250822



code: 250752



code: 250502



code: 250352



code: 711022 & 970752

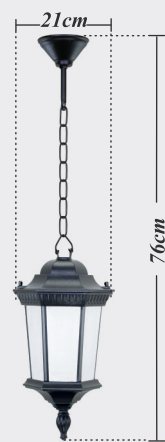

code: 711012



code: 711032



code: 711022 & 910772

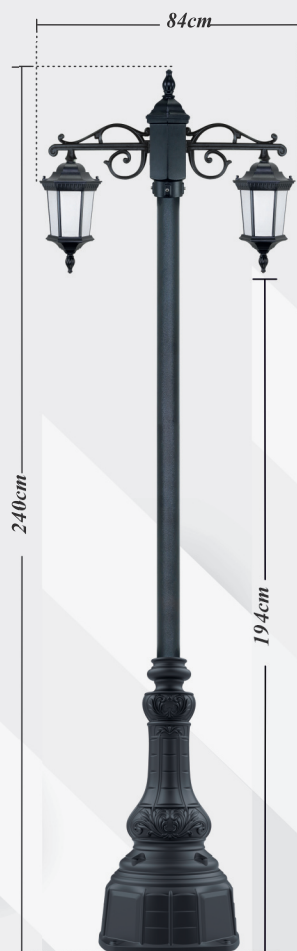

code: 712712 & 972022

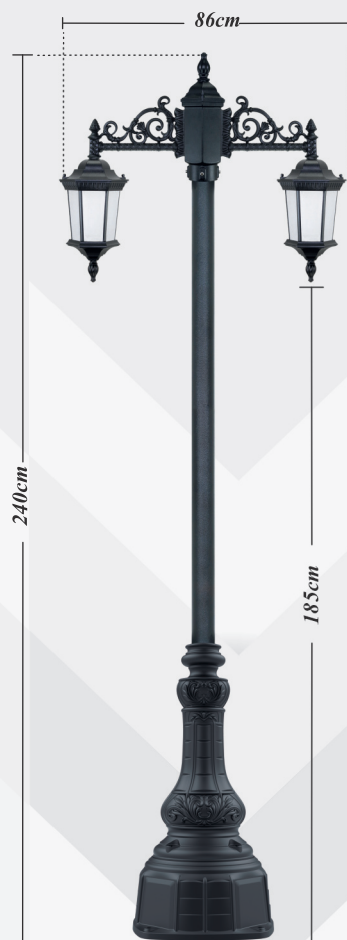

code: 712512 & 972022

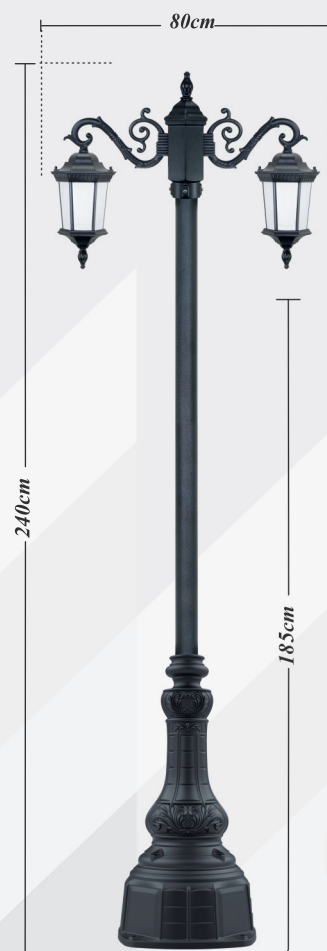

code: 712212 & 972022

رابو

- منبع مصرفی لامپ: E27
- جنس بدنه: آلومینیوم دایکاست
- جنس حباب: پلی کربنات
- درجه حفاظت: IP 44
- پوشش بدنه: رنگ پودری الکترواستاتیک
- توان: 30W
- رنگ بدنه: ■ ■
- ولتاژ ورودی: AC220V/50HZ
- پیچ: استیل

Rabo

- Lamp consumption source: E27
- Property of Body: Die-cast aluminum
- Property of bubble: Polycarbonate
- IP degree of Protection: 44
- Body coating: electrostatic power paint
- Power: 30 W
- Color of body: ■ ■
- Input Voltage: AC220V/50HZ
- Screw: Steel

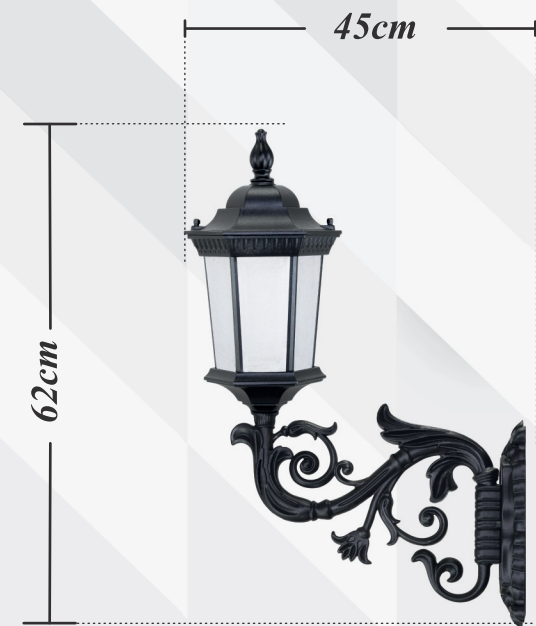

code: 710422



code: 710122



code: 710212



code: 710722



code: 710622



code: 710312



code: 710522



code: 721022 & 970752



code: 721012



code: 721032



code: 721022 & 910772



code: 722112 & 972022

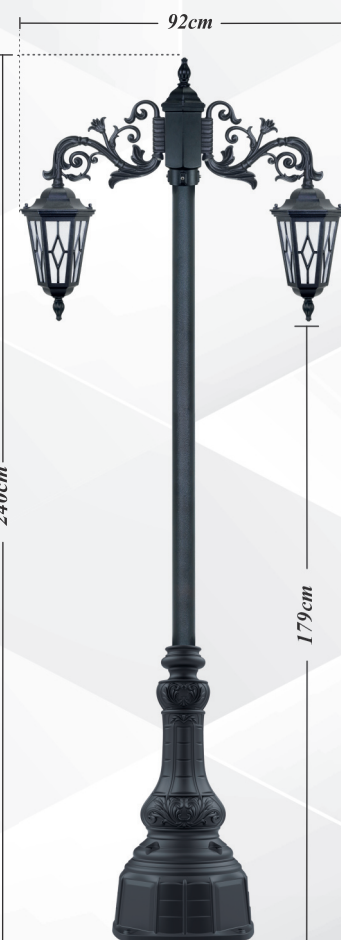

code: 722412 & 972022

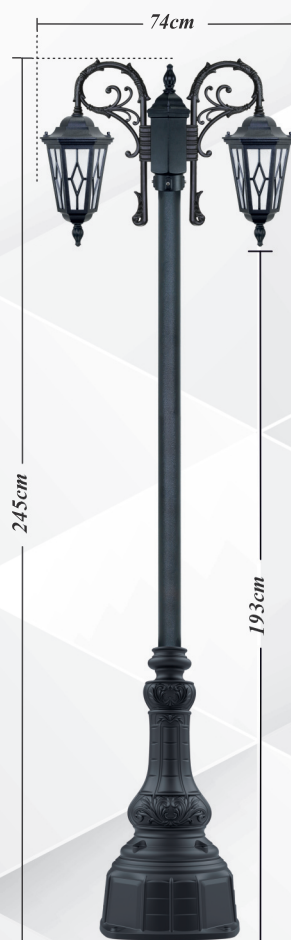

code: 722312 & 972022

ویسپر

- منبع مصرفی لامپ: E27
- جنس بدنه: آلومینیوم دایکاست
- جنس حباب: پلی کربنات
- درجه حفاظت: IP 44
- پوشش بدنه: رنگ پودری الکترواستاتیک
- توان: 30W
- رنگ بدنه: ■ ■
- ولتاژ ورودی: AC220V/50HZ
- پیچ: استیل

Whisper

- Lamp consumption source: E27
- Property of Body: Die-cast aluminum
- Property of bubble: Polycarbonate
- IP degree of Protection: 44
- Body coating: electrostatic power paint
- Power: 30 W
- Color of body: ■ ■
- Input Voltage: AC220V/50HZ
- Screw: Steel



code: 720122



code: 720212



code: 720722



code: 720612



code: 720322



code: 720412



code: 720522



code: 731022 & 970752



code: 731012



code: 731032



code: 731022 & 910772



code: 732712 & 972022

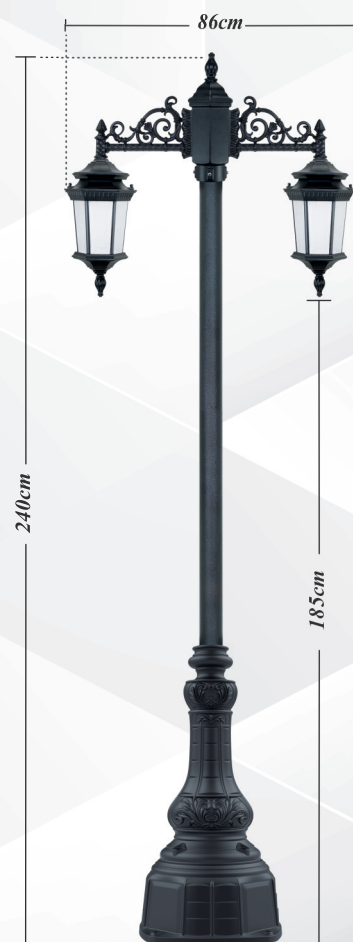

code: 732512 & 972022

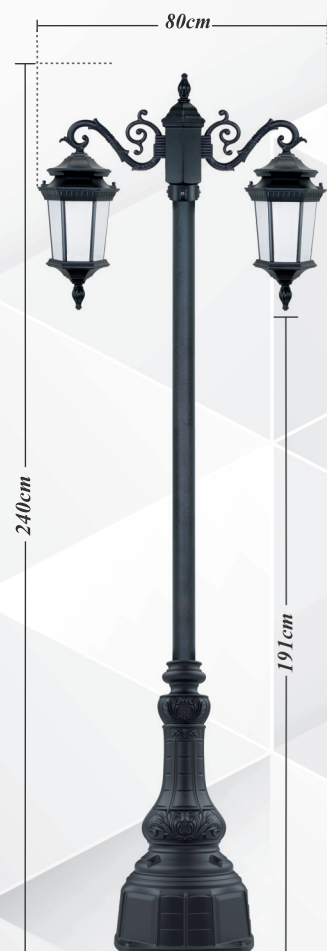

code: 732212 & 972022

معبد رابو

- منبع مصرفی لامپ: E27
- جنس بدنه: آلومینیوم دایکاست
- جنس حباب: پلی کربنات
- درجه حفاظت: IP 44
- پوشش بدنه: رنگ پودری الکترواستاتیک
- توان: 30W
- رنگ بدنه: ■ ■
- ولتاژ ورودی: AC220V/50HZ
- پیچ: استیل

Rabo's Temple

- Lamp consumption source: E27
- Property of Body: Die-cast aluminum
- Property of bubble: Polycarbonate
- IP degree of Protection: 44
- Body coating: electrostatic power paint
- Power: 30 W
- Color of body: ■ ■
- Input Voltage: AC220V/50HZ
- Screw: Steel



code: 730212



code: 730122



code: 730712



code: 730622



code: 730312



code: 730422



code: 730512



code: 741022 & 970752



code: 741012



code: 741032



code: 741022 & 910772



code: 742112 & 972022

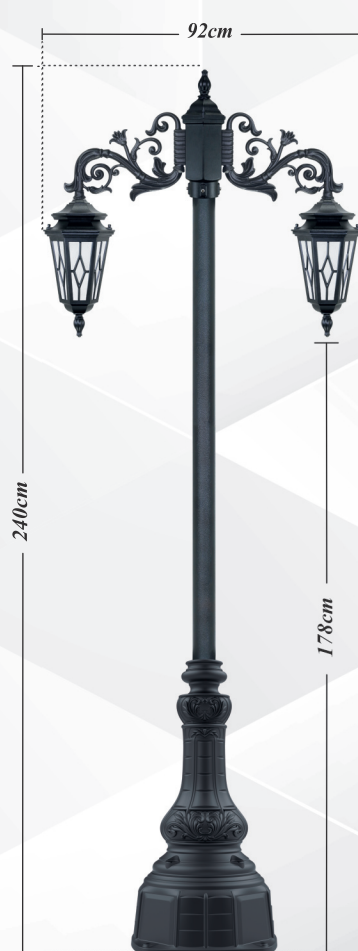

code: 742412 & 972022

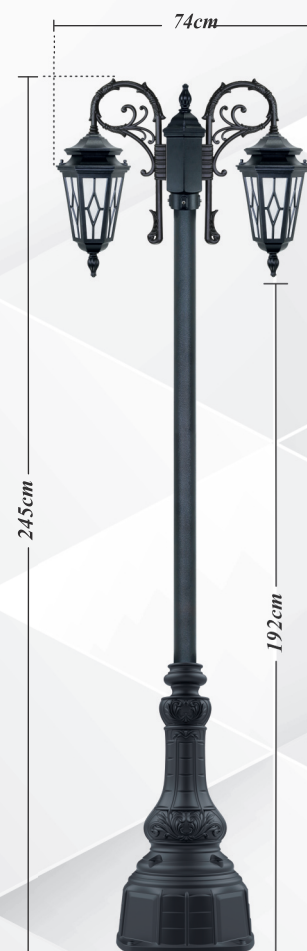

code: 742312 & 972022

معبد ویسپر

- منبع مصرفی لامپ: E27
- جنس بدنه: آلومینیوم دایکاست
- جنس حباب: پلی کربنات
- درجه حفاظت: IP 44
- پوشش بدنه: رنگ پودری الکترواستاتیک
- توان: 30W
- رنگ بدنه: ■ ■
- ولتاژ ورودی: AC220V/50HZ
- پیچ: استیل

Whisper's Temple

- Lamp consumption source: E27
- Property of Body: Die-cast aluminum
- Property of bubble: Polycarbonate
- IP degree of Protection: 44
- Body coating: electrostatic power paint
- Power: 30 W
- Color of body: ■ ■
- Input Voltage: AC220V/50HZ
- Screw: Steel



code: 740722



code: 740122



code: 740212



code: 740612



code: 740322



code: 740412



code: 740522

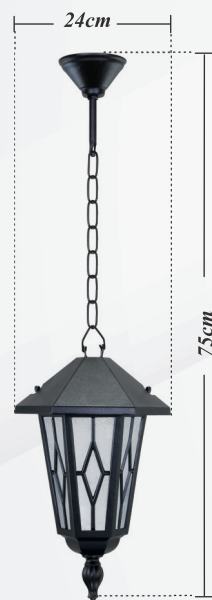

code: 761012



code: 761032



code: 760622



code: 762112 & 972022



code: 761022 & 910772



code: 761022 & 970752

ویکتور

- منبع مصرفی لامپ: E27
- جنس بدنه: آلومینیوم دایکاست
- جنس حباب: پلی کربنات
- درجه حفاظت: IP 44
- پوشش بدنه: رنگ پودری الکترواستاتیک
- توان: 30W
- رنگ بدنه: ■ ■
- ولتاژ ورودی: AC220V/50HZ
- پیچ: استیل

Victor

- Lamp consumption source: E27
- Property of Body: Die-cast aluminum
- Property of bubble: Polycarbonate
- IP degree of Protection: 44
- Body coating: electrostatic power paint
- Power: 30 W
- Color of body: ■ ■
- Input Voltage: AC220V/50HZ
- Screw: Steel

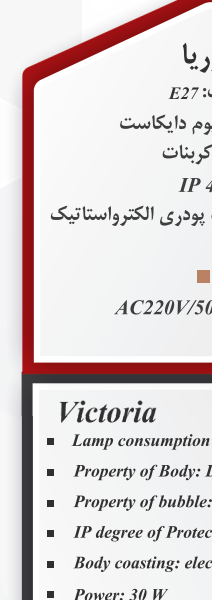

code: 751012



code: 811032



code: 820622

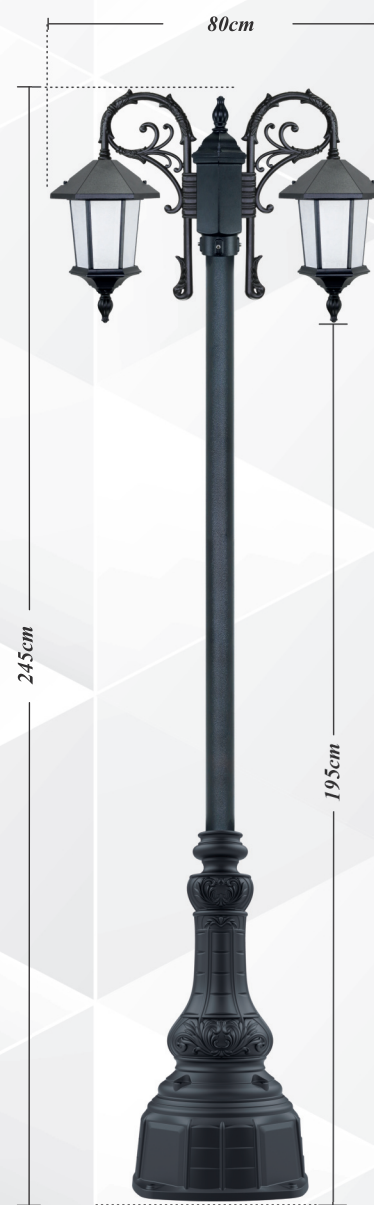

code: 752312 & 972022



code: 821022 & 970752



code: 811022 & 910772

ویکتوریا

- منبع مصرفی لامپ: E27
- جنس بدنه: آلومینیوم دایکاست
- جنس حباب: پلی کربنات
- درجه حفاظت: IP 44
- پوشش بدنه: رنگ پودری الکترواستاتیک
- توان: 30W
- رنگ بدنه: ■ ■
- ولتاژ ورودی: AC220V/50HZ
- پیچ: استیل

Victoria

- Lamp consumption source: E27
- Property of Body: Die-cast aluminum
- Property of bubble: Polycarbonate
- IP degree of Protection: 44
- Body coating: electrostatic power paint
- Power: 30 W
- Color of body: ■ ■
- Input Voltage: AC220V/50HZ
- Screw: Steel





code: 781012



code: 781032



code: 780122



code: 782212 & 972022



code: 781022 & 910772



code: 781022 & 970752

رابو کمرباریک

- منبع مصرفی لامپ: E27
- جنس بدنه: آلومینیوم دایکاست
- جنس حباب: پلی کریبات
- درجه حفاظت: IP 44
- پوشش بدنه: رنگ پودری الکترواستاتیک
- توان: 30W
- رنگ بدنه: ■ ■
- ولتاژ ورودی: AC220V/50HZ
- پیچ: استیل

Slim Rabo

- Lamp consumption source: E27
- Property of Body: Die-cast aluminum
- Property of bubble: Polycarbonate
- IP degree of Protection: 44
- Body coating: electrostatic power paint
- Power: 30 W
- Color of body: ■ ■
- Input Voltage: AC220V/50HZ
- Screw: Steel



رابو خمه ای

- منبع مصرفی لامپ: E27
- جنس بدنه: آلومینیوم دایکاست
- جنس حباب: پلی کریبات
- درجه حفاظت: IP 44
- پوشش بدنه: رنگ پودری الکترواستاتیک
- توان: 30W
- رنگ بدنه: ■ ■
- ولتاژ ورودی: AC220V/50HZ
- پیچ: استیل

Vase Rabo

- Lamp consumption source: E27
- Property of Body: Die-cast aluminum
- Property of bubble: Polycarbonate
- IP degree of Protection: 44
- Body coating: electrostatic power paint
- Power: 30 W
- Color of body: ■ ■
- Input Voltage: AC220V/50HZ
- Screw: Steel

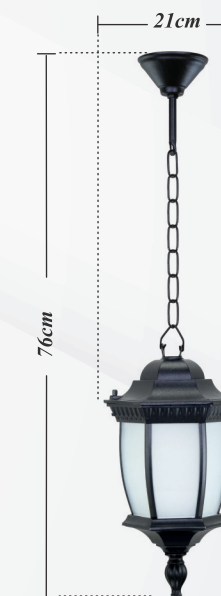

code: 771012



code: 771032



code: 770312

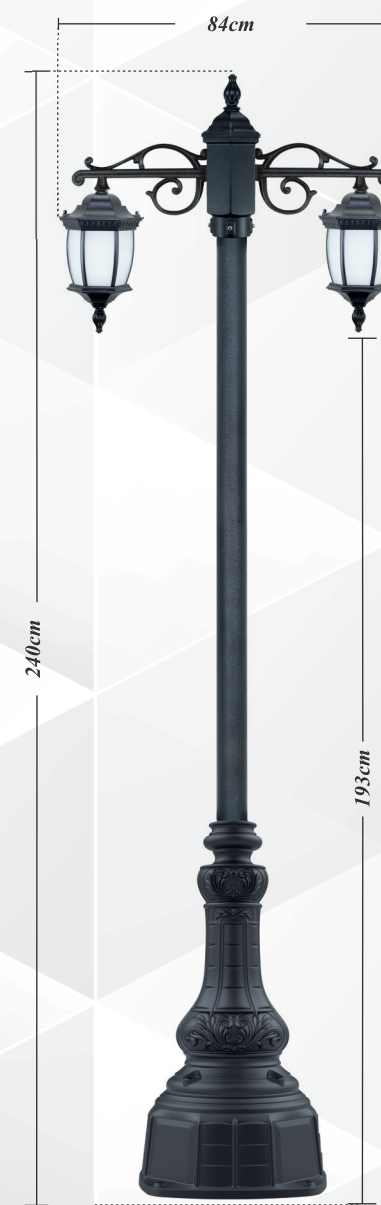

code: 772712 & 972022



code: 771022 & 970752



code: 771022 & 910772



code: 801012



code: 801032



code: 800412



code: 802512 & 972022



code: 801022 & 910772



code: 801022 & 970752

معبد رابو کمرباریک

- منبع مصرفی لامپ: E27
- جنس بدنه: آلومینیوم دایکاست
- جنس حباب: پلی کربنات
- درجه حفاظت: IP 44
- پوشش بدنه: رنگ پودری الکترواستاتیک
- توان: 30W
- رنگ بدنه: ■ ■
- ولتاژ ورودی: AC220V/50HZ
- پیچ: استیل

Slim Rabo's Temple

- Lamp consumption source: E27
- Property of Body: Die-cast aluminum
- Property of bubble: Polycarbonate
- IP degree of Protection: 44
- Body coating: electrostatic power paint
- Power: 30 W
- Color of body: ■ ■
- Input Voltage: AC220V/50HZ
- Screw: Steel

معبد رابو خمیره ای

- منبع مصرفی لامپ: E27
- جنس بدنه: آلومینیوم دایکاست
- جنس حباب: پلی کربنات
- درجه حفاظت: IP 44
- پوشش بدنه: رنگ پودری الکترواستاتیک
- توان: 30W
- رنگ بدنه: ■ ■
- ولتاژ ورودی: AC220V/50HZ
- پیچ: استیل

Vase Rabo's Temple

- Lamp consumption source: E27
- Property of Body: Die-cast aluminum
- Property of bubble: Polycarbonate
- IP degree of Protection: 44
- Body coating: electrostatic power paint
- Power: 30 W
- Color of body: ■ ■
- Input Voltage: AC220V/50HZ
- Screw: Steel



code: 791022 & 970752



code: 791022 & 910772



code: 792412 & 972022

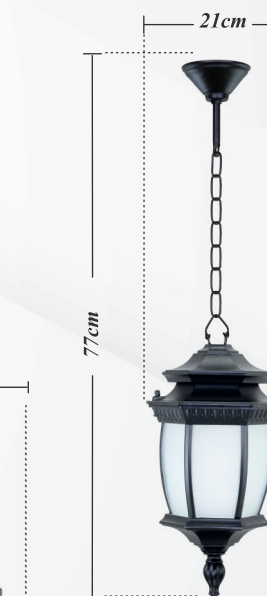

code: 791012



code: 791032



code: 790512

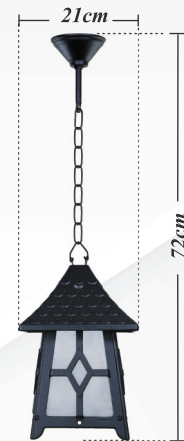

code: 831012

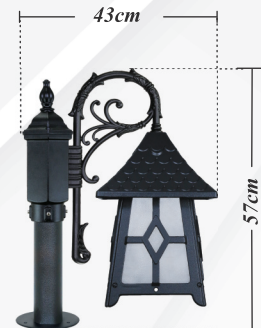

code: 831312 & 9230

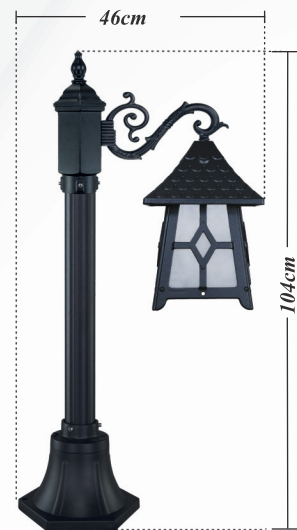

code: 831212 & 910772

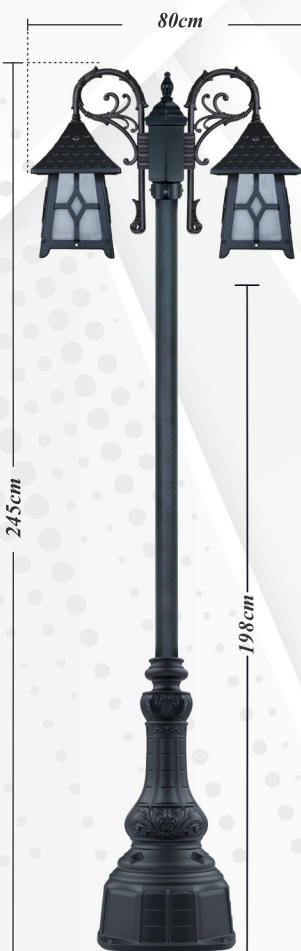

code: 832312 & 972022

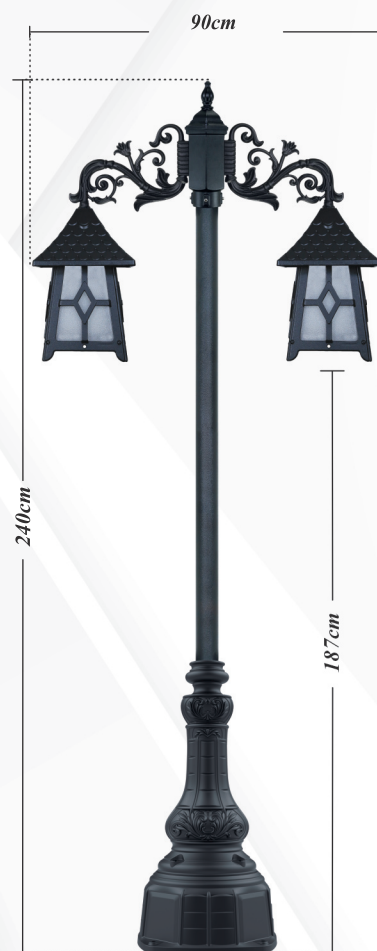

code: 832412 & 972022

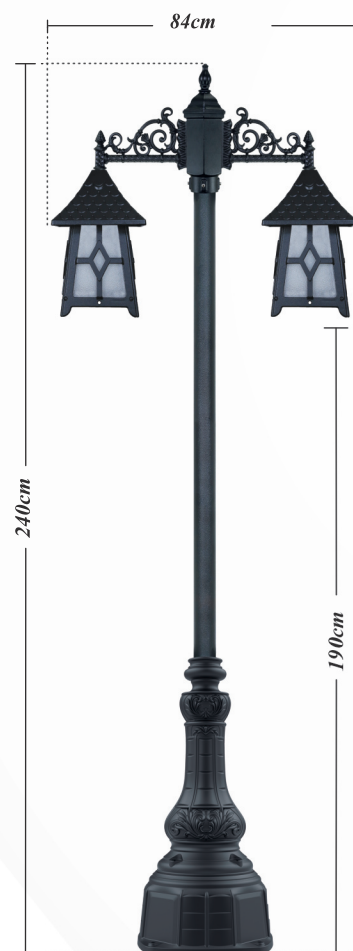

code: 832512 & 972022

کلبه

- منبع مصرفی لامپ: E27
- جنس بدنه: آلومینیوم دایکاست
- جنس حباب: پلی کربنات
- درجه حفاظت: IP 44
- پوشش بدنه: رنگ پودری الکترواستاتیک
- توان: 30W
- رنگ بدنه: ■ ■
- ولتاژ ورودی: AC220V/50HZ
- پیچ: استیل

Cottage

- Lamp consumption source: E27
- Property of Body: Die-cast aluminum
- Property of bubble: Polycarbonate
- IP degree of Protection: 44
- Body coating: electrostatic power paint
- Power: 30 W
- Color of body: ■ ■
- Input Voltage: AC220V/50HZ
- Screw: Steel

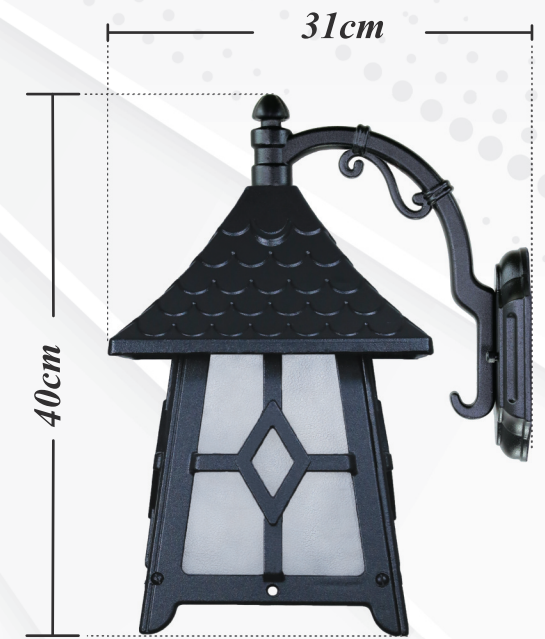

code: 830112

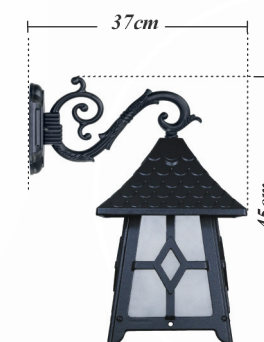

code: 830212

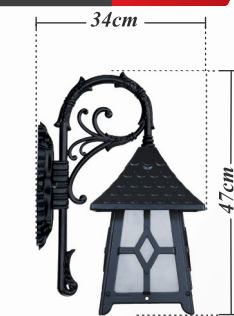

code: 830312



code: 830712

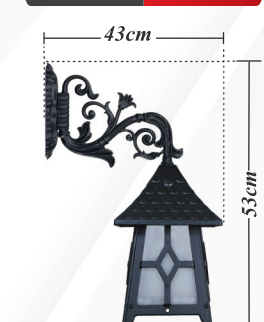

code: 830412



code: 830612

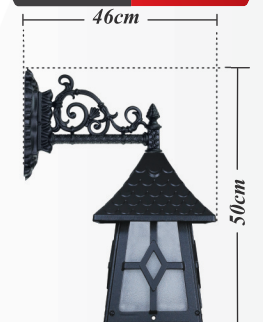

code: 830512



code: 841022 & 970752



code: 841012



code: 841032



code: 841022 & 910772

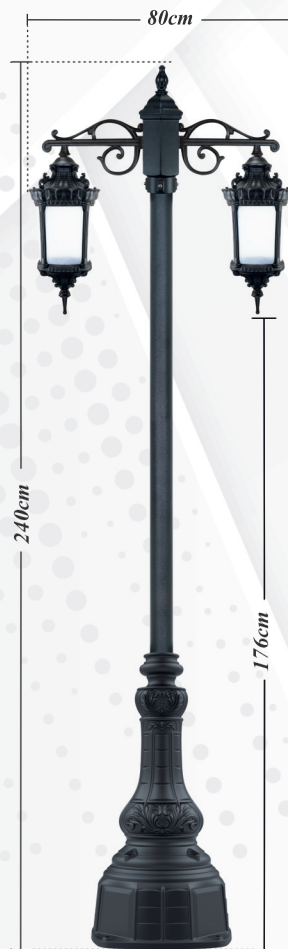

code: 842712 & 972022

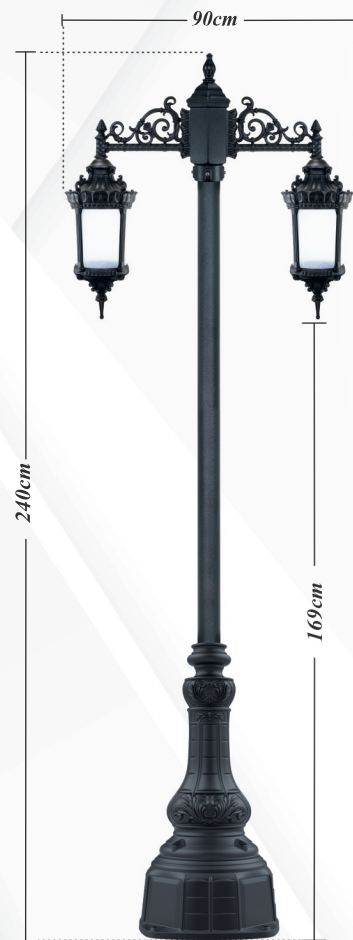

code: 842512 & 972022

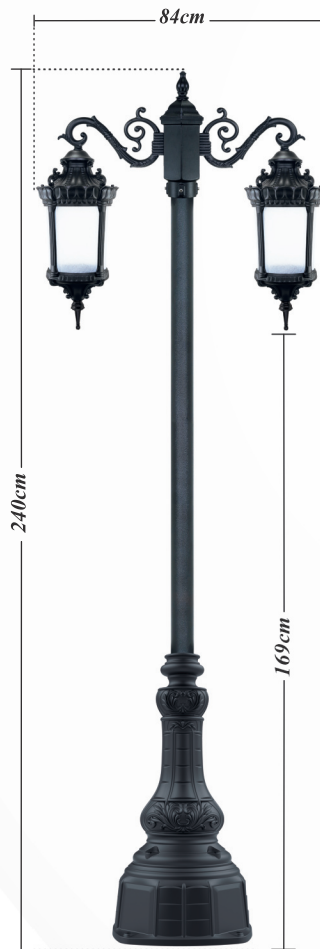

code: 842212 & 972022

روبینا

- منبع مصرفی لامپ: E27
- جنس بدنه: آلومینیوم دایکاست
- جنس حباب: پلی کربنات
- درجه حفاظت: IP 44
- پوشش بدنه: رنگ پودری الکترواستاتیک
- توان: 30W
- رنگ بدنه: ■ ■ ■
- ولتاژ ورودی: AC220V/50HZ
- پیچ: استیل

Robbina

- Lamp consumption source: E27
- Property of Body: Die-cast aluminum
- Property of bubble: Polycarbonate
- IP degree of Protection: 44
- Body coating: electrostatic power paint
- Power: 30 W
- Color of body: ■ ■ ■
- Input Voltage: AC220V/50HZ
- Screw: Steel



code: 840212



code: 840122



code: 840712



code: 840622



code: 840312



code: 840422



code: 840512



code: 851022 & 970752

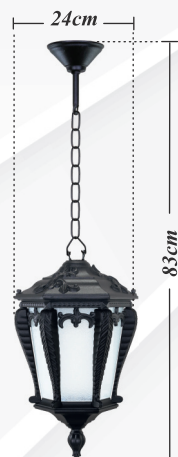

code: 851012



code: 851032



code: 851022 & 910772

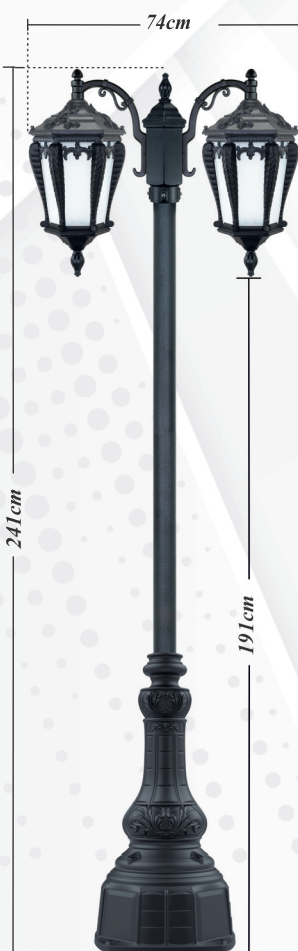

code: 852112 & 972022

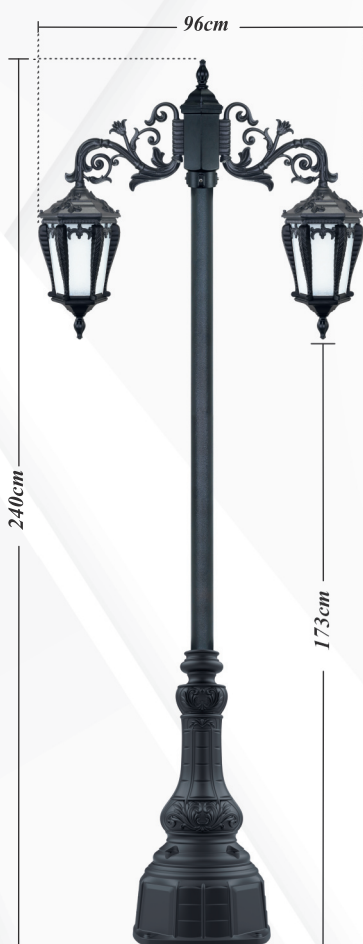

code: 852412 & 972022

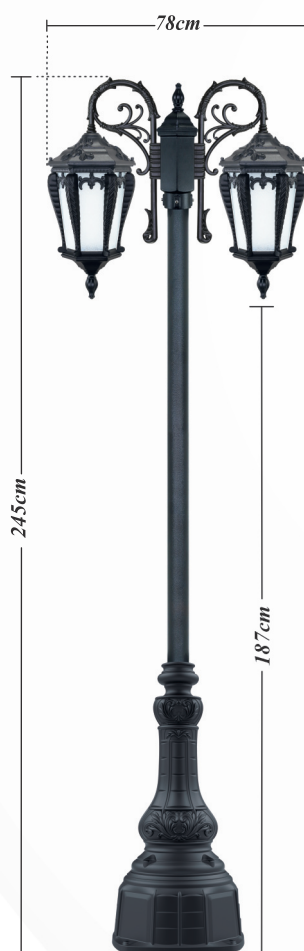

code: 852312 & 972022

پالیز

- منبع مصرفی لامپ: E27
- جنس بدنه: آلومینیوم دایکاست
- جنس حباب: پلی کربنات
- درجه حفاظت: IP 44
- پوشش بدنه: رنگ پودری الکترواستاتیک
- توان: 30W
- رنگ بدنه: ■ ■
- ولتاژ ورودی: AC220V/50HZ
- پیچ: استیل

palliz

- Lamp consumption source: E27
- Property of Body: Die-cast aluminum
- Property of bubble: Polycarbonate
- IP degree of Protection: 44
- Body coating: electrostatic power paint
- Power: 30 W
- Color of body: ■ ■
- Input Voltage: AC220V/50HZ
- Screw: Steel



code: 850122



code: 850212



code: 850722



code: 850612



code: 850322



code: 850412



code: 850522

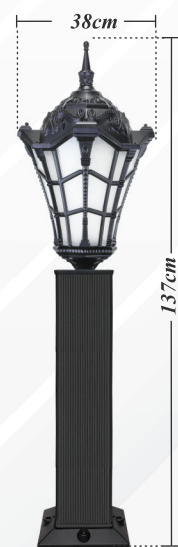

code:861022 & 970752



code: 861012



code: 861032



code:861022 & 910772

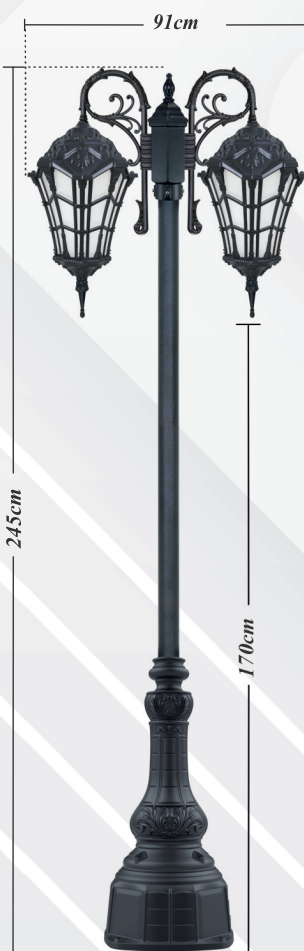

code:862312 & 972022



code:862412 & 972022

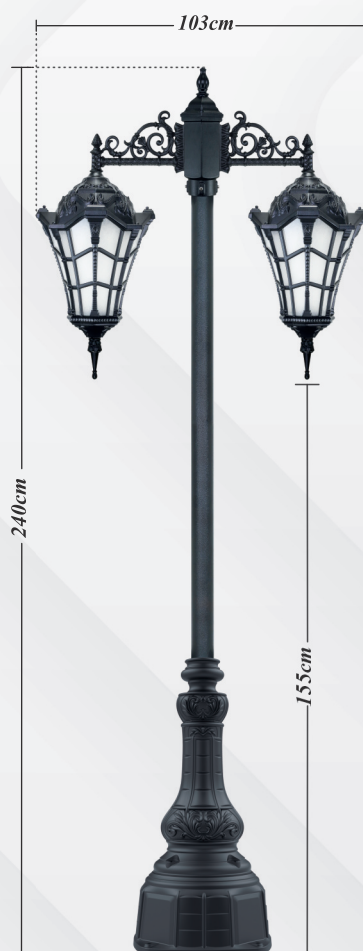

code: 862512 & 972022

وستا بزرگ

- منبع مصرفی لامپ: E27
- جنس بدنه: آلومینیوم دایکاست
- جنس حباب: پلی کربنات
- درجه حفاظت: IP 44
- پوشش بدنه: رنگ پودری الکترواستاتیک
- توان: 30W
- رنگ بدنه: ■ ■ ■
- ولتاژ ورودی: AC220V/50HZ
- پیچ: استیل

Great Vesta

- Lamp consumption source: E27
- Property of Body: Die-cast aluminum
- Property of bubble: Polycarbonate
- IP degree of Protection: 44
- Body coating: electrostatic power paint
- Power: 30 W
- Color of body: ■ ■ ■
- Input Voltage: AC220V/50HZ
- Screw: Steel



code: 860412



code: 860122



code: 860212



code: 860222



code: 860312



code: 860322



code: 860512



code:871022& 970752



code: 871012



code: 871032



code:871022 & 910772

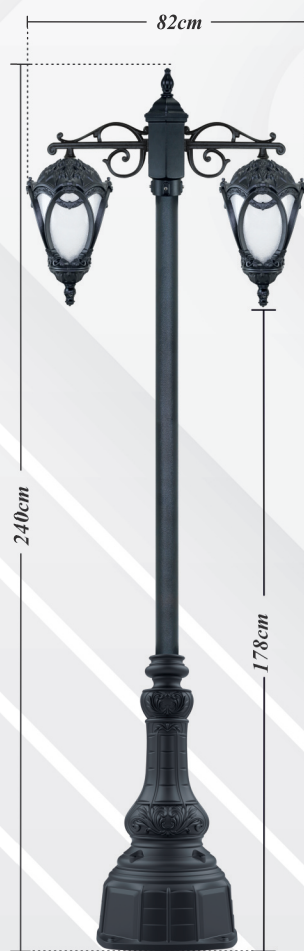

code:872712 & 972022

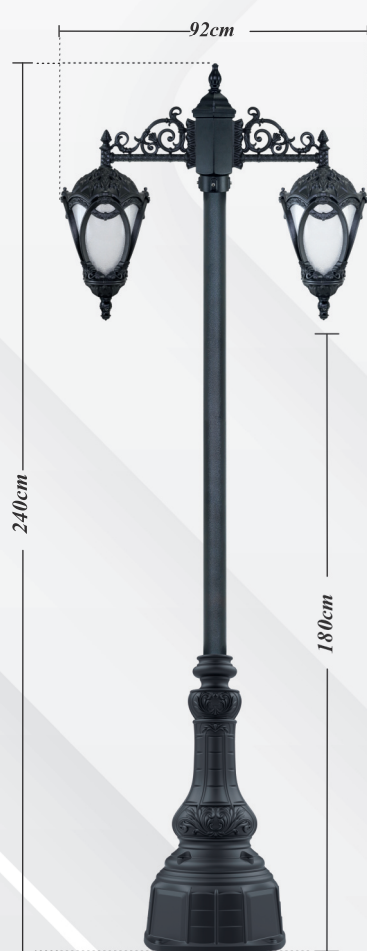

code:872512 & 972022

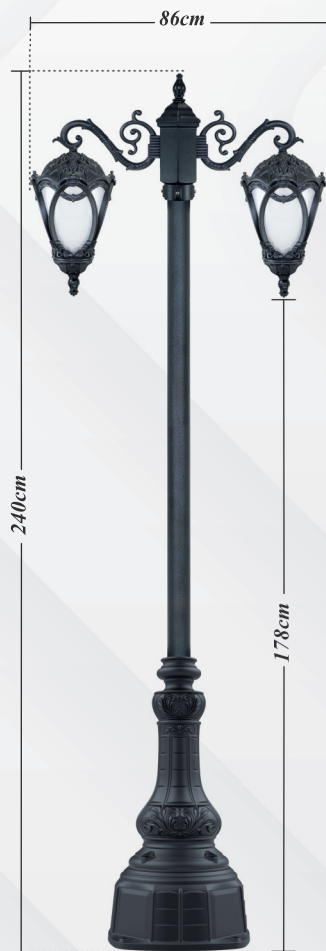

code:872212 & 972022

مهرگان

- منبع مصرفی لامپ: E27
- جنس بدنه: آلومینیوم دایکاست
- جنس حباب: پلی کربنات
- درجه حفاظت: IP 44
- پوشش بدنه: رنگ پودری الکترواستاتیک
- توان: 30W
- رنگ بدنه: ■ ■
- ولتاژ ورودی: AC220V/50HZ
- پیچ: استیل

Mehrgan

- Lamp consumption source: E27
- Property of Body: Die-cast aluminum
- Property of bubble: Polycarbonate
- IP degree of Protection: 44
- Body coating: electrostatic power paint
- Power: 30 W
- Color of body: ■ ■
- Input Voltage: AC220V/50HZ
- Screw: Steel



code: 870212



code: 870122



code: 870712



code: 870622



code: 870312



code: 870422



code: 870512



code: 881022 & 970752



code: 881012



code: 881032



code: 881022 & 910772

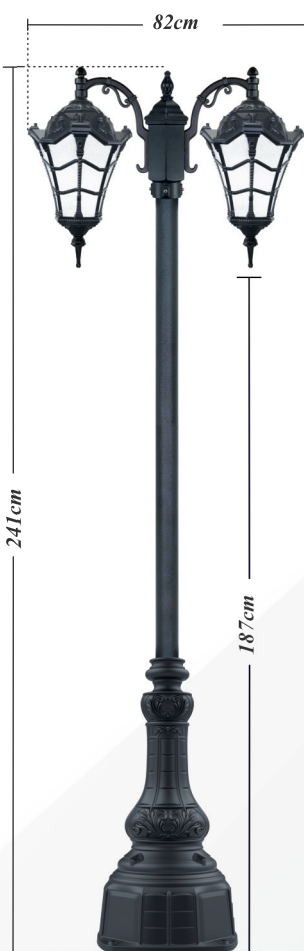

code: 882112 & 972022

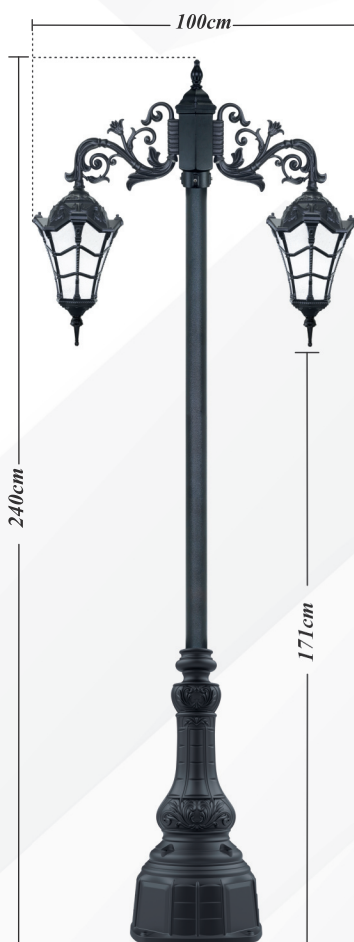

code: 882412 & 972022

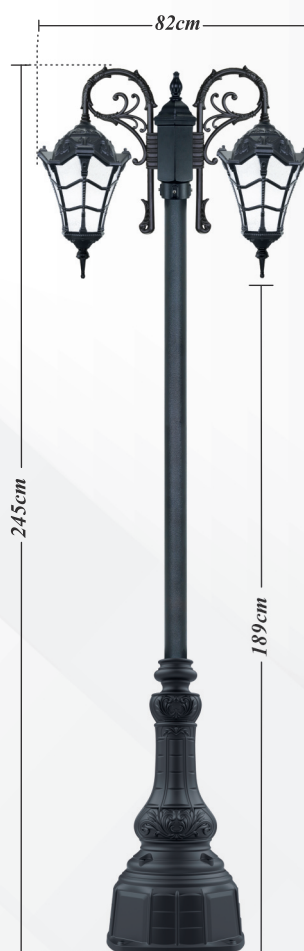

code: 882312 & 972022

وستا کوچک

- منبع مصرفی لامپ: E27
- جنس بدنه: آلومینیوم دایکاست
- جنس حباب: پلی کربنات
- درجه حفاظت: IP 44
- پوشش بدنه: رنگ پودری الکترواستاتیک
- توان: 30W
- رنگ بدنه: ■ ■
- ولتاژ ورودی: AC220V/50HZ
- پیچ: استیل

Small Vesta

- Lamp consumption source: E27
- Property of Body: Die-cast aluminum
- Property of bubble: Polycarbonate
- IP degree of Protection: 44
- Body coating: electrostatic power paint
- Power: 30 W
- Color of body: ■ ■
- Input Voltage: AC220V/50HZ
- Screw: Steel



code: 880512



code: 880122



code: 880212



code: 880722



code: 880612



code: 880312



code: 880422



پادرا

- منبع مصرفی لامپ: E27
- جنس بدنه: آلومینیوم دایکاست
- جنس حباب: پلی کربنات
- درجه حفاظت: IP 44
- پوشش بدنه: رنگ پودری الکترواستاتیک
- توان: 30W
- رنگ بدنه: ■ ■ ■
- ولتاژ ورودی: AC220V/50HZ
- پیچ: استیل

Paadra

- Lamp consumption source: E27
- Property of Body: Die-cast aluminum
- Property of bubble: Polycarbonate
- IP degree of Protection: 44
- Body coating: electrostatic power paint
- Power: 30 W
- Color of body: ■ ■ ■
- Input Voltage: AC220V/50HZ
- Screw: Steel

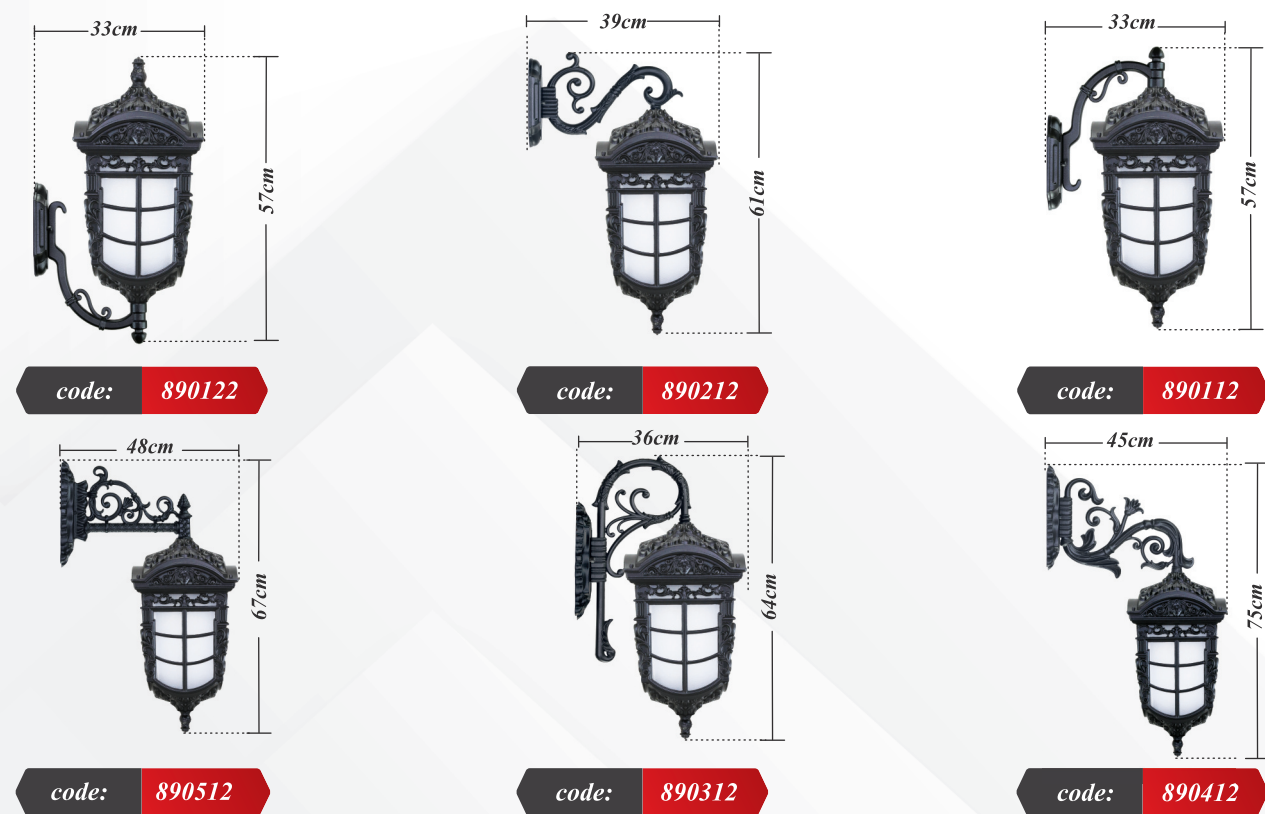



code: 901018



code: 901038



code: 900218

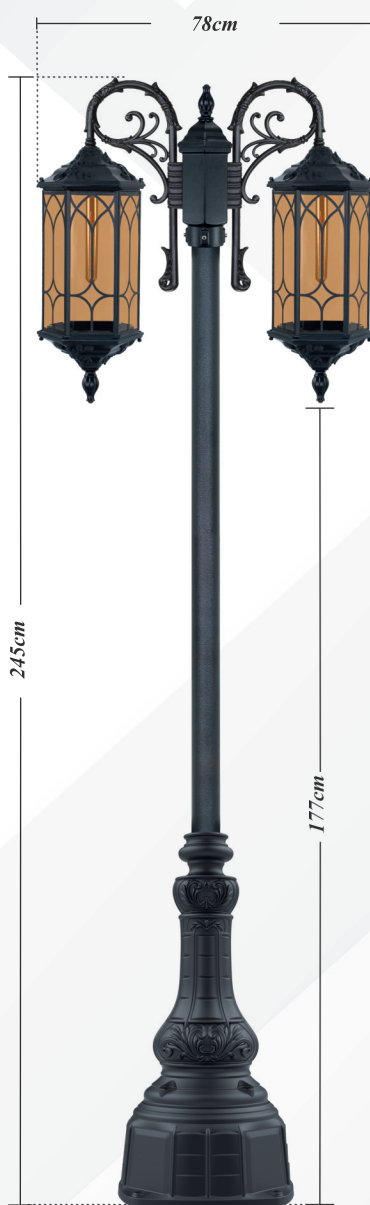

code: 902318 & 972022



code: 901028 & 910772

پادینا طرح دار

- منبع مصرفی لامپ: E27
- جنس بدنه: آلومینیوم دایکاست
- جنس حباب: شیشه
- درجه حفاظت: IP 44
- پوشش بدنه: رنگ پودری الکترواستاتیک
- توان: 30W
- رنگ بدنه: ■ ■
- ولتاژ ورودی: AC220V/50HZ
- پیچ: استیل

Pattern paddina

- Lamp consumption source: E27
- Property of Body: Die-cast aluminum
- Property of bubble: Glass
- IP degree of Protection: 44
- Body coating: electrostatic power paint
- Power: 30 W
- Color of body: ■ ■
- Input Voltage: AC220V/50HZ
- Screw: Steel

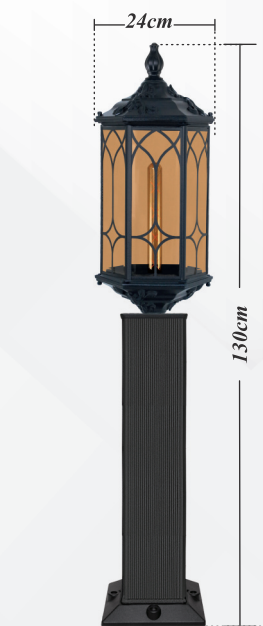

code: 901028 & 970752

پادینا

- منبع مصرفی لامپ: E27
- جنس بدنه: آلومینیوم دایکاست
- جنس حباب: شیشه
- درجه حفاظت: IP 44
- پوشش بدنه: رنگ پودری الکترواستاتیک
- توان: 30W
- رنگ بدنه: ■ ■
- ولتاژ ورودی: AC220V/50HZ
- پیچ: استیل

Paddina

- Lamp consumption source: E27
- Property of Body: Die-cast aluminum
- Property of bubble: Glass
- IP degree of Protection: 44
- Body coating: electrostatic power paint
- Power: 30 W
- Color of body: ■ ■
- Input Voltage: AC220V/50HZ
- Screw: Steel



code: 901022 & 970752



code: 901022 & 910772

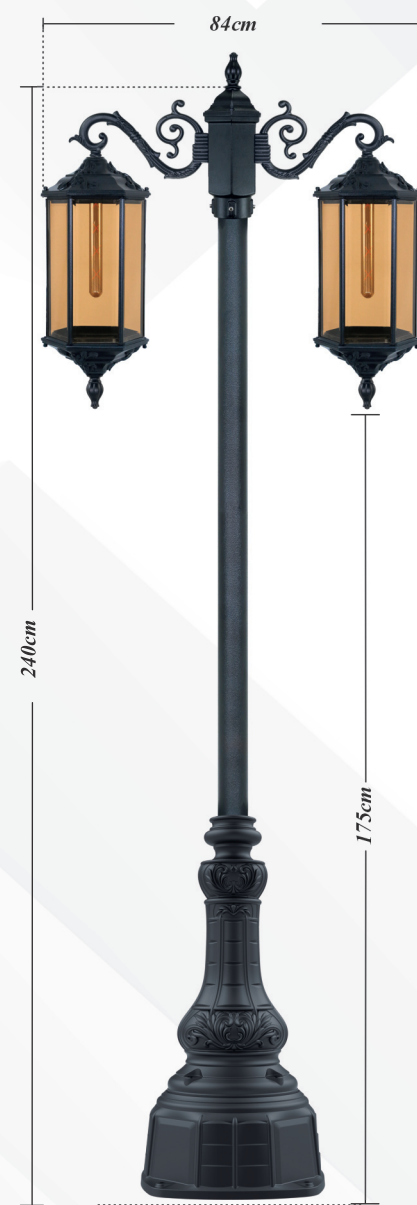

code: 902212 & 972022



code: 901012



code: 901032



code: 900312



بیس پلیت	ارتفاع نهایی	کد محصول	نام محصول
-	60-300	Ta-932402	پایه تو خاکی
مثلت ۱۶۰ آکس ۱۲۰	210	Ta-922102	پایه روکار فلنج دار تبدیل ۸ به ۶
مثلت ۱۶۰ آکس ۱۲۰	120-300	Ta-922002	پایه رو کار فلنج دار
مثلت ۱۴۰ آکس ۱۰۰	60-120	Ta-921202	پایه رو کار فلنج دار
-	200	Ta-972002	پایه آرتمیس
-	125	Ta-971252	پایه آرتمیس
-	77	Ta-910778	پایه گلدونی



بیس پلیت	ارتفاع نهایی	کد محصول	نام محصول
-	200	Ta-972022	پایه آرتان بزرگ
-	200	Ta-972012	پایه آرتان کوچک
-	70	Ta-970702	کاور پایه آرتان بزرگ
-	53	Ta-970532	کاور پایه آرتان کوچک
مثلت ۱۶۰ آکس ۱۲۰	70	Ta-960702	کاور پایه ساویز بزرگ
مثلت ۱۶۰ آکس ۱۲۰	54	Ta-960542	کاور پایه ساویز کوچک